



EVOTECH®
P E R F O R M A N C E

www.evotech-performance.com

Honda CBR 1000 RR-R / SP Tail Tidy

Installation Instructions



Kit Contents PRN014802

- (A) 1 x Retro Light
- (B) 1 x Con 26 Loom Connector
- (C) 2 x M4 Flange Nuts
- (D) 2 x M5 x 16 Black Button Head Bolts
- (E) 4 x M5 x 12 Caphead Bolts

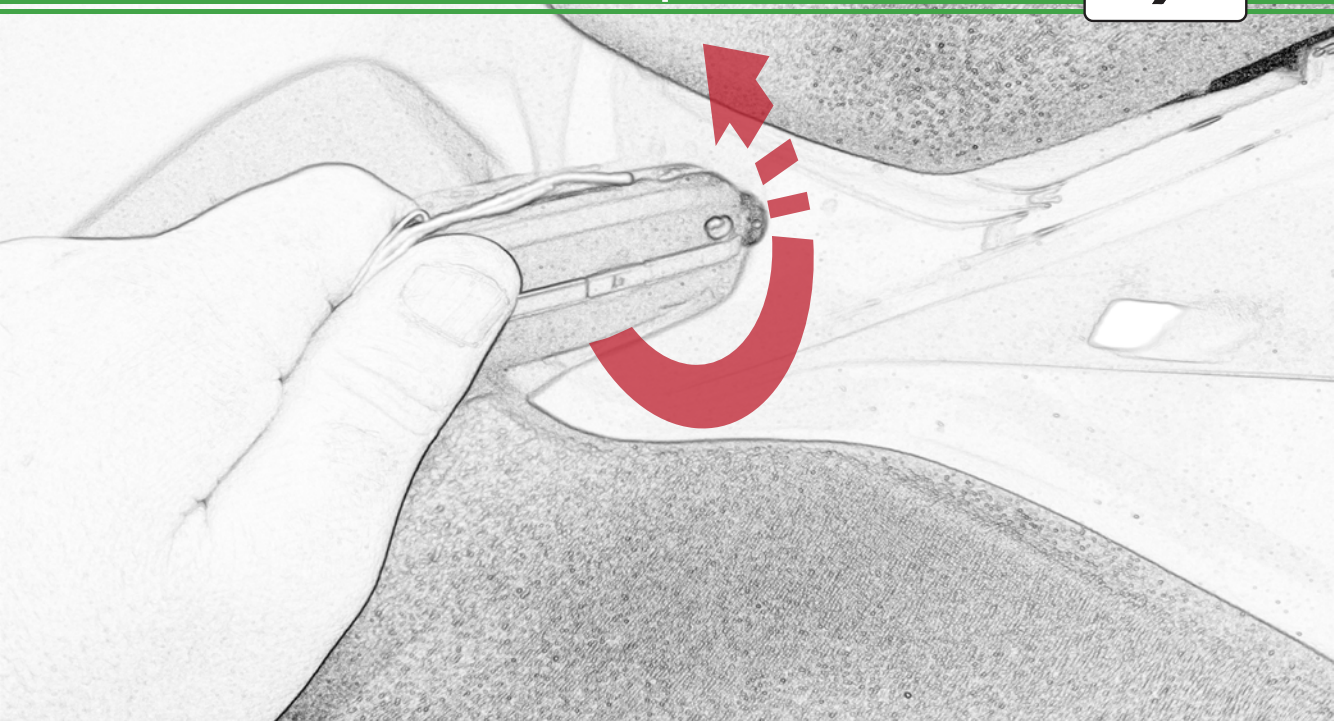

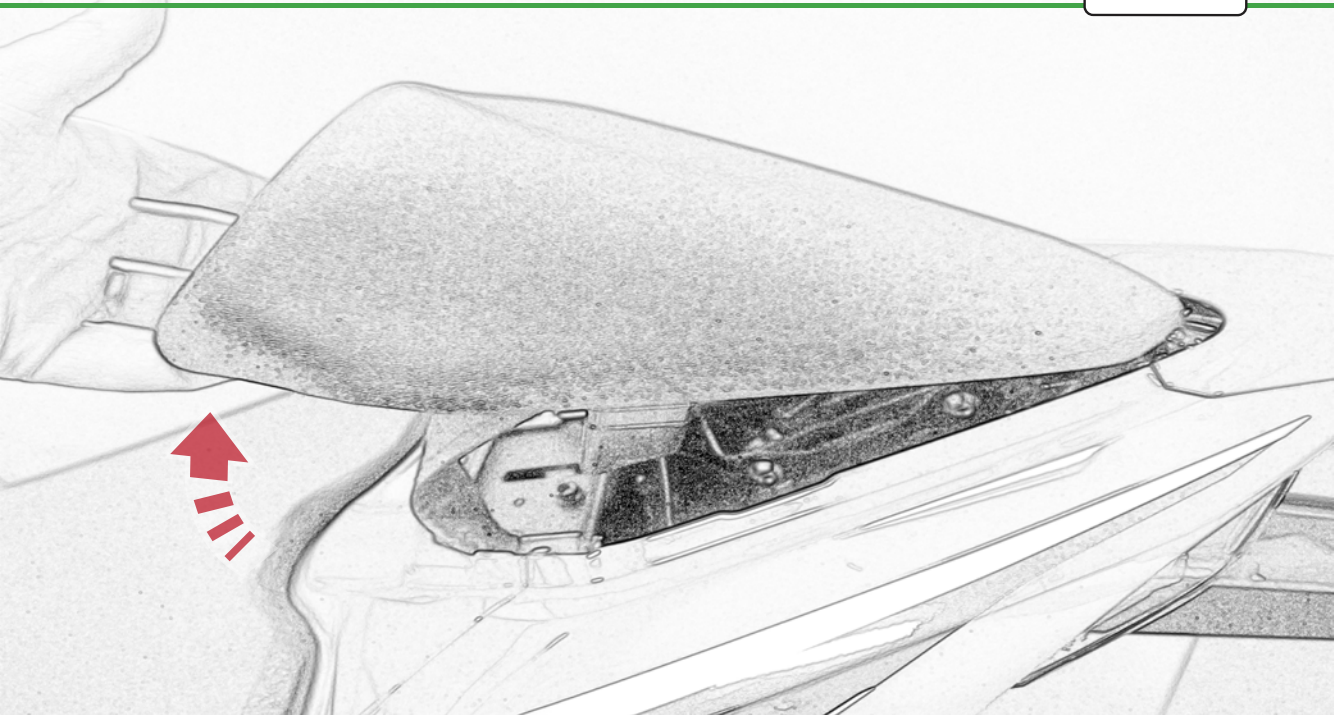

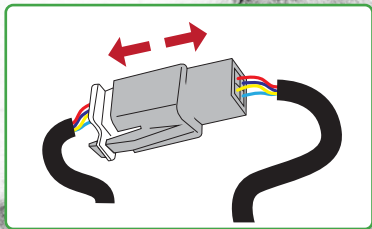
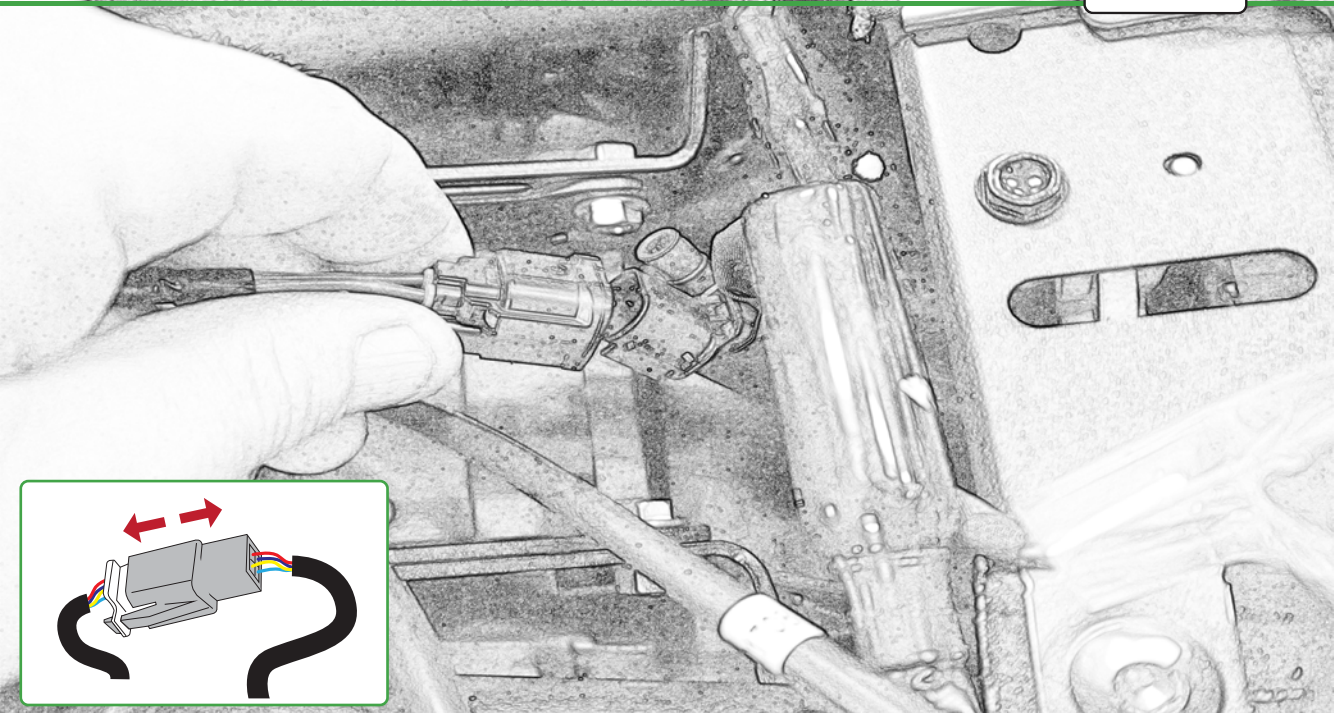

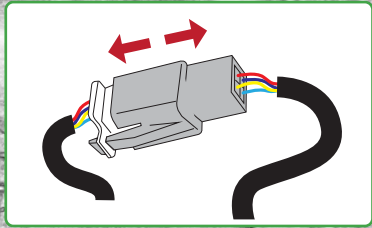
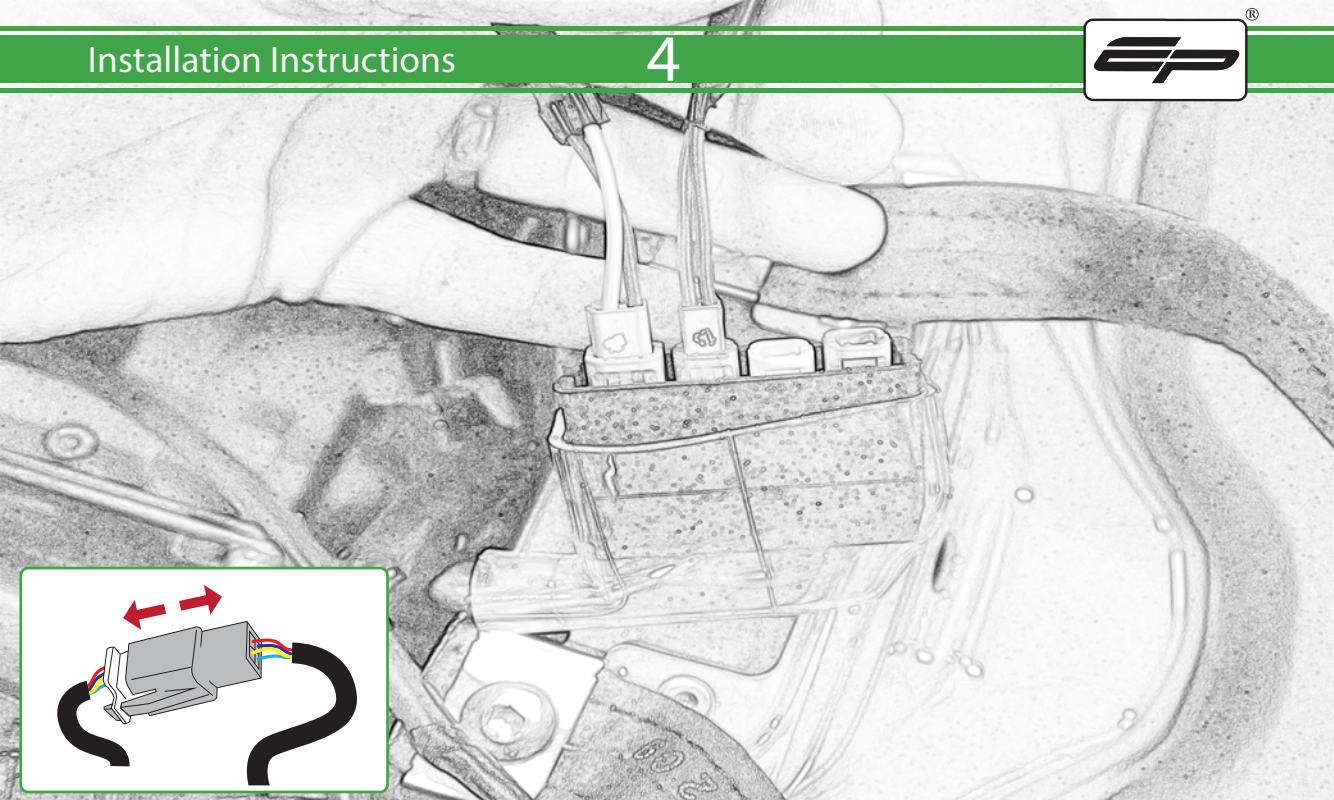

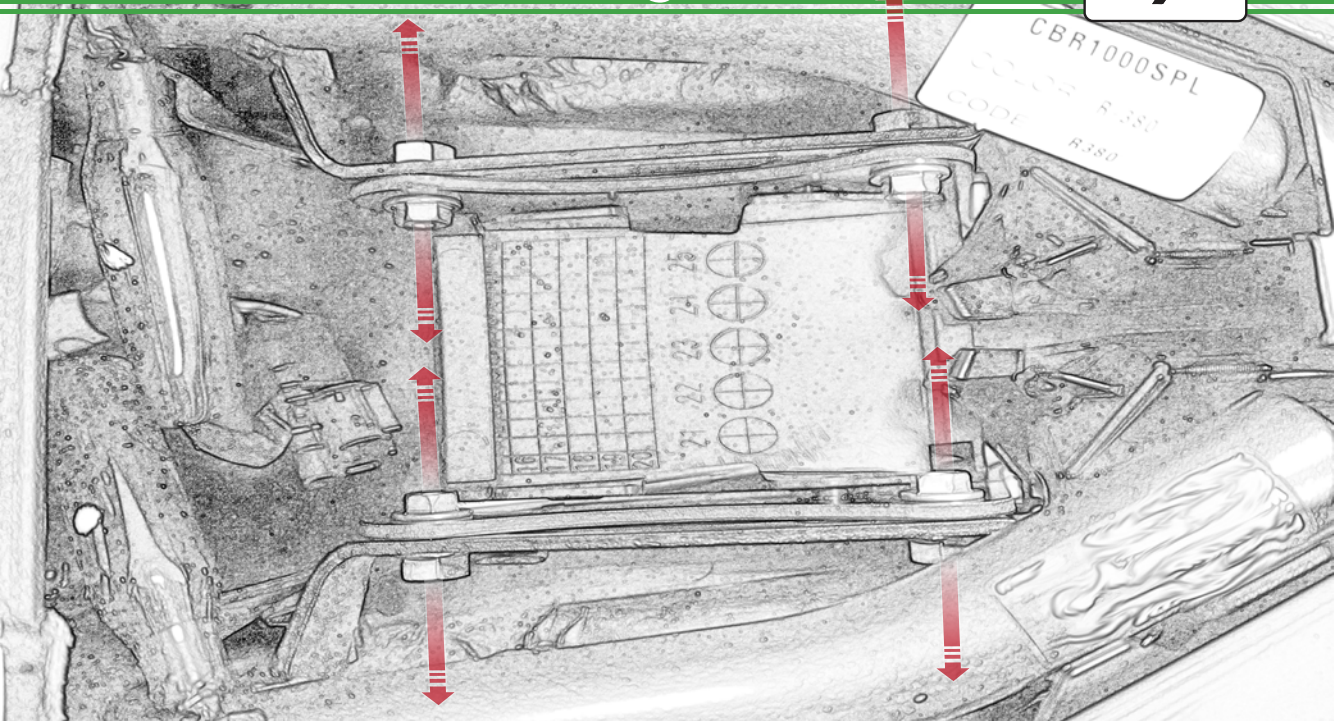

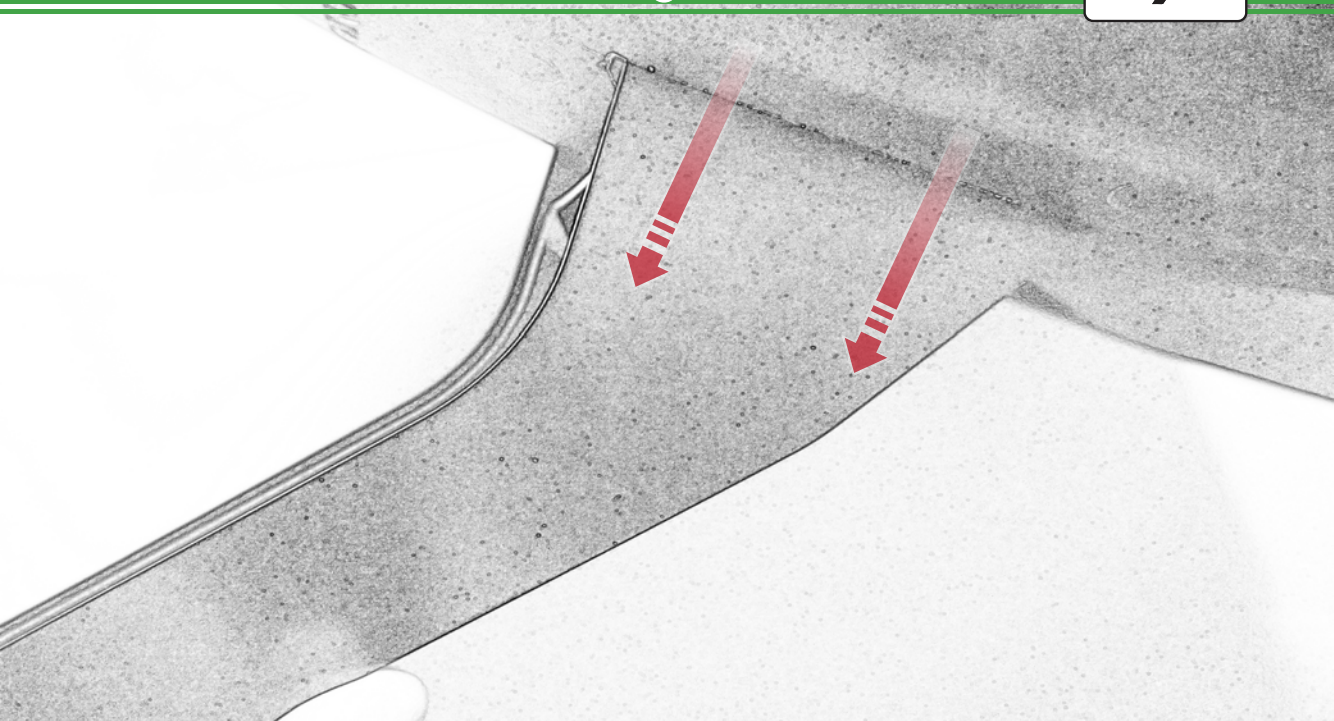

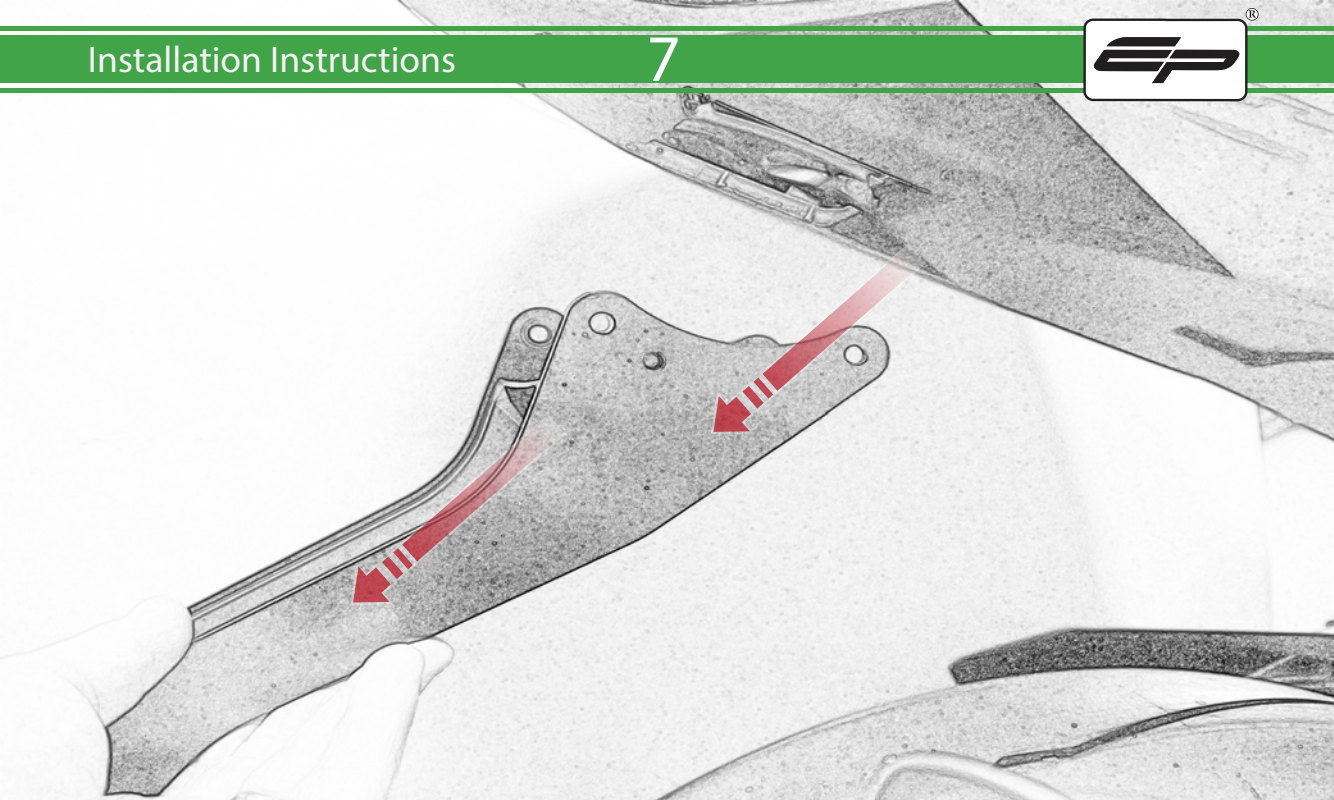

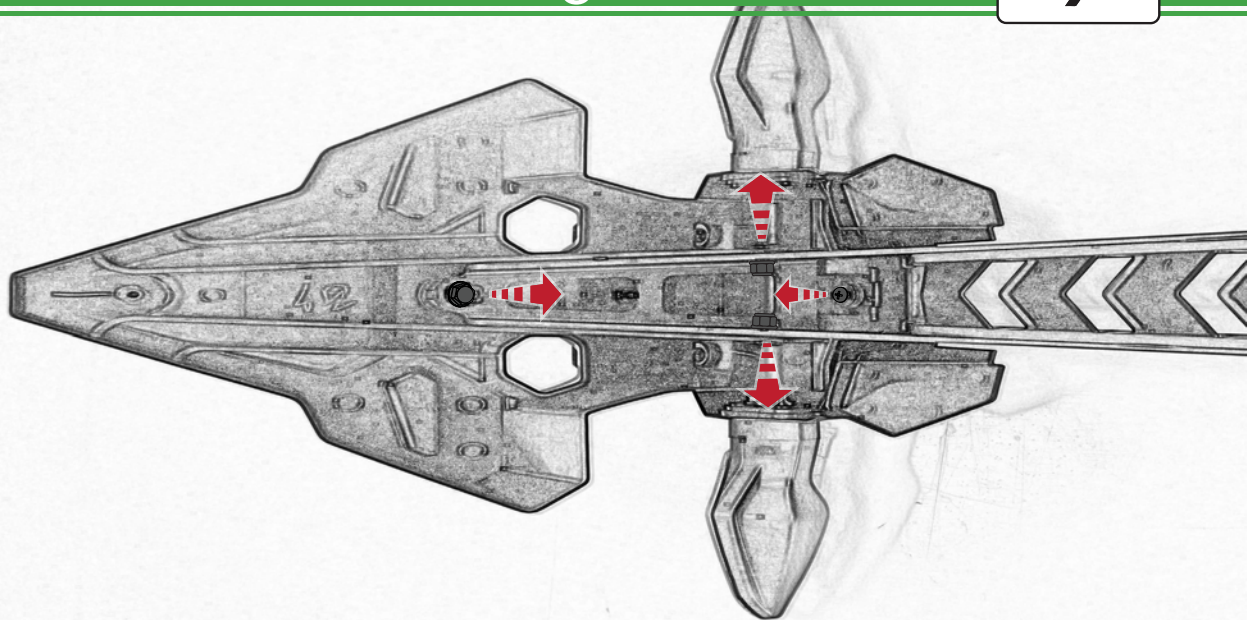

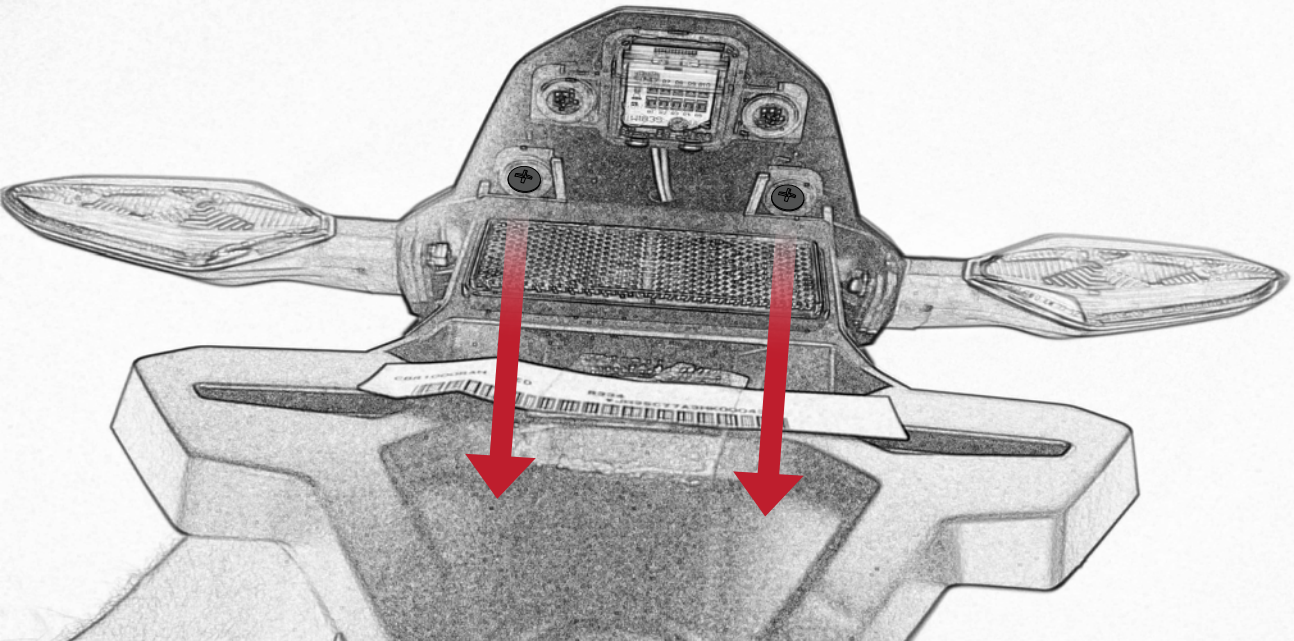

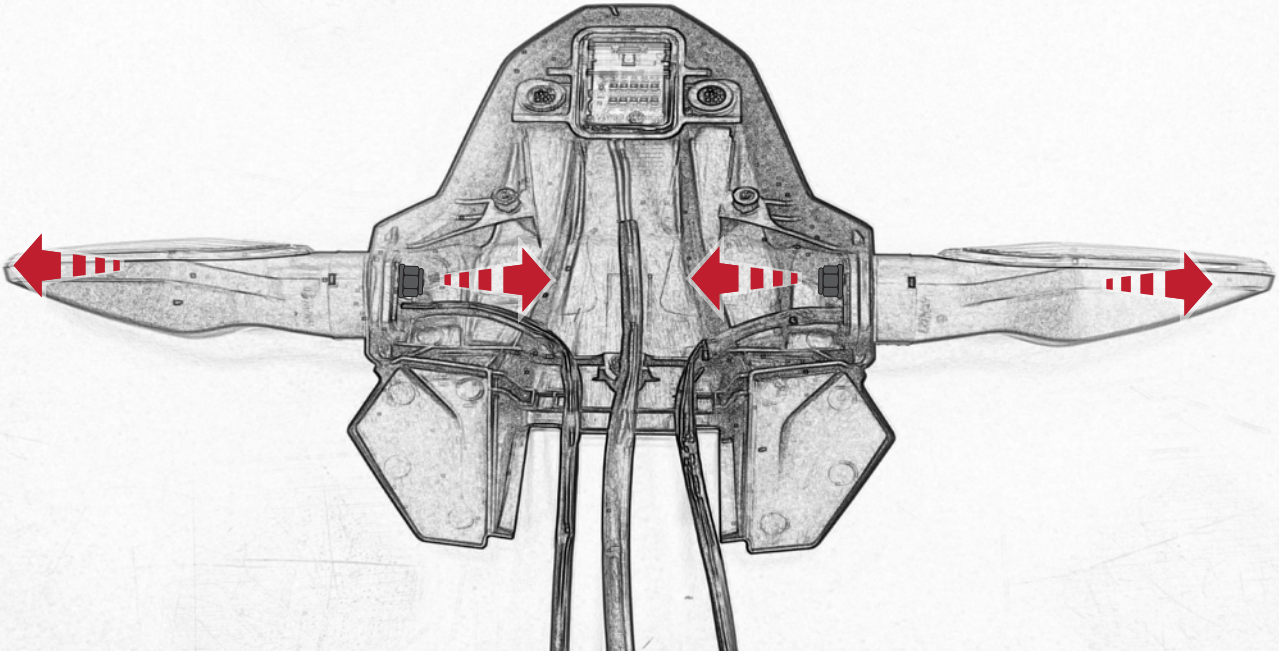

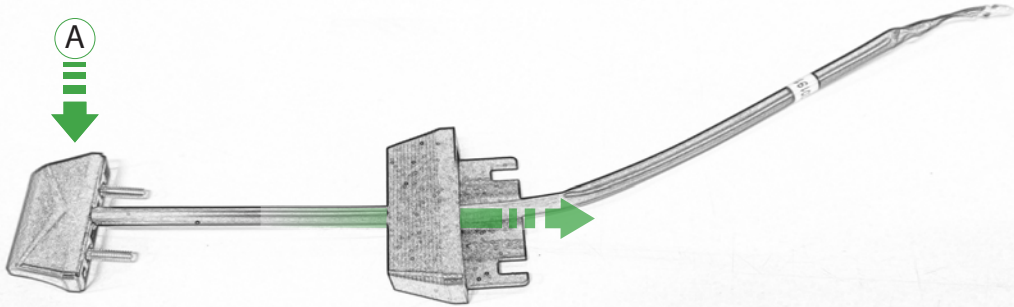

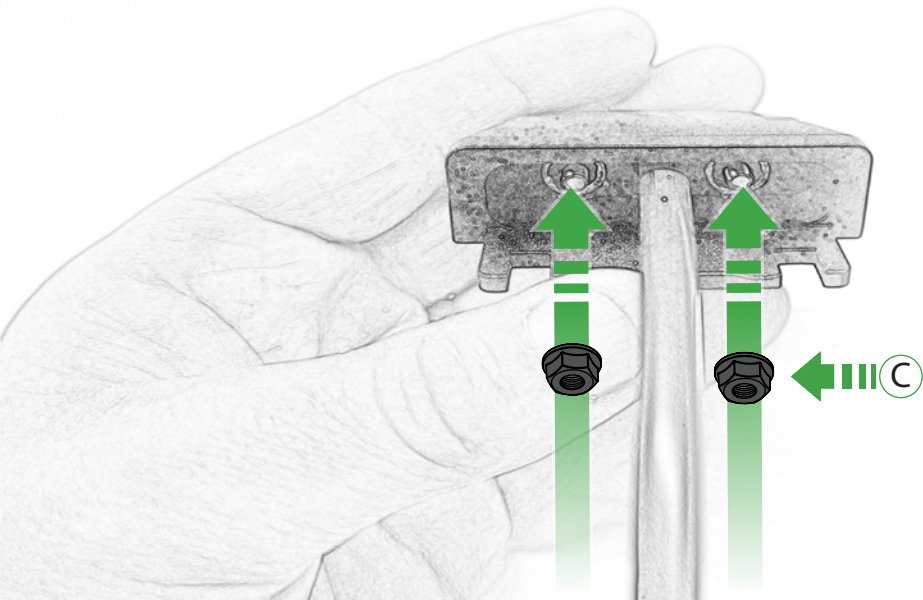

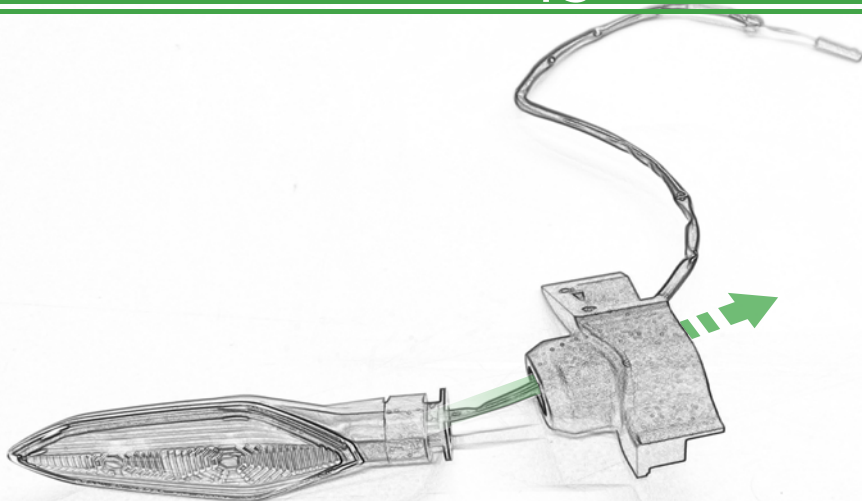

Repeat
Both Sides

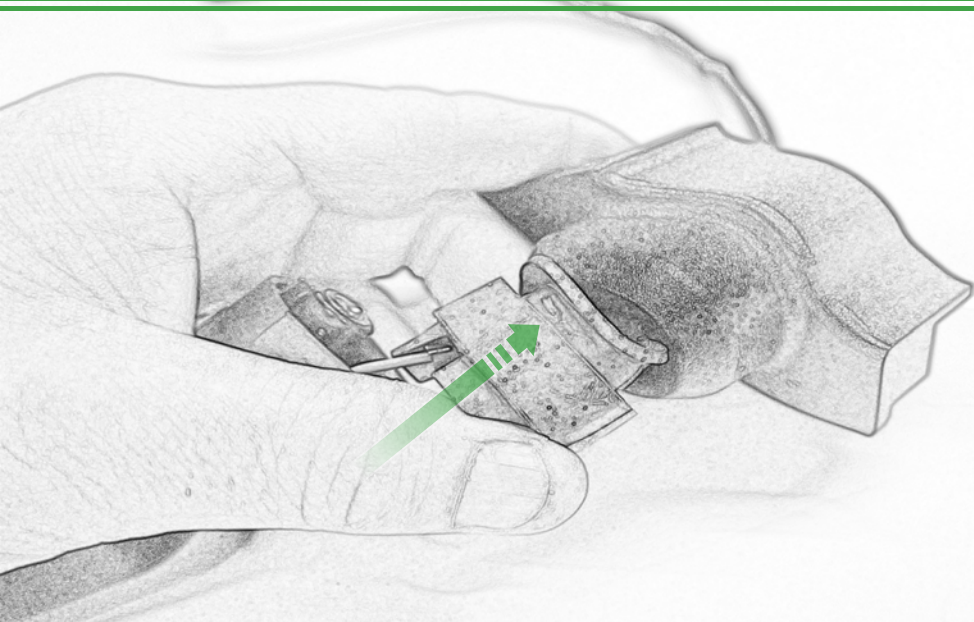

Repeat
Both Sides

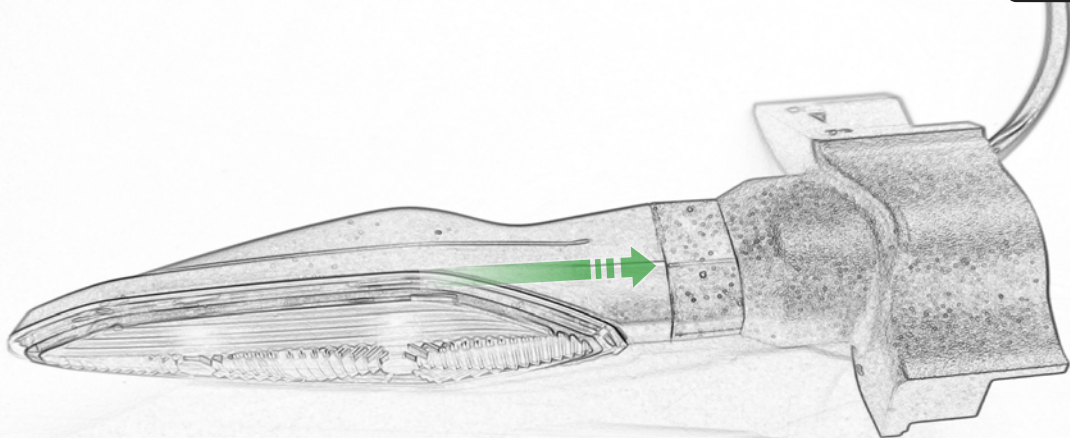

Repeat
Both Sides

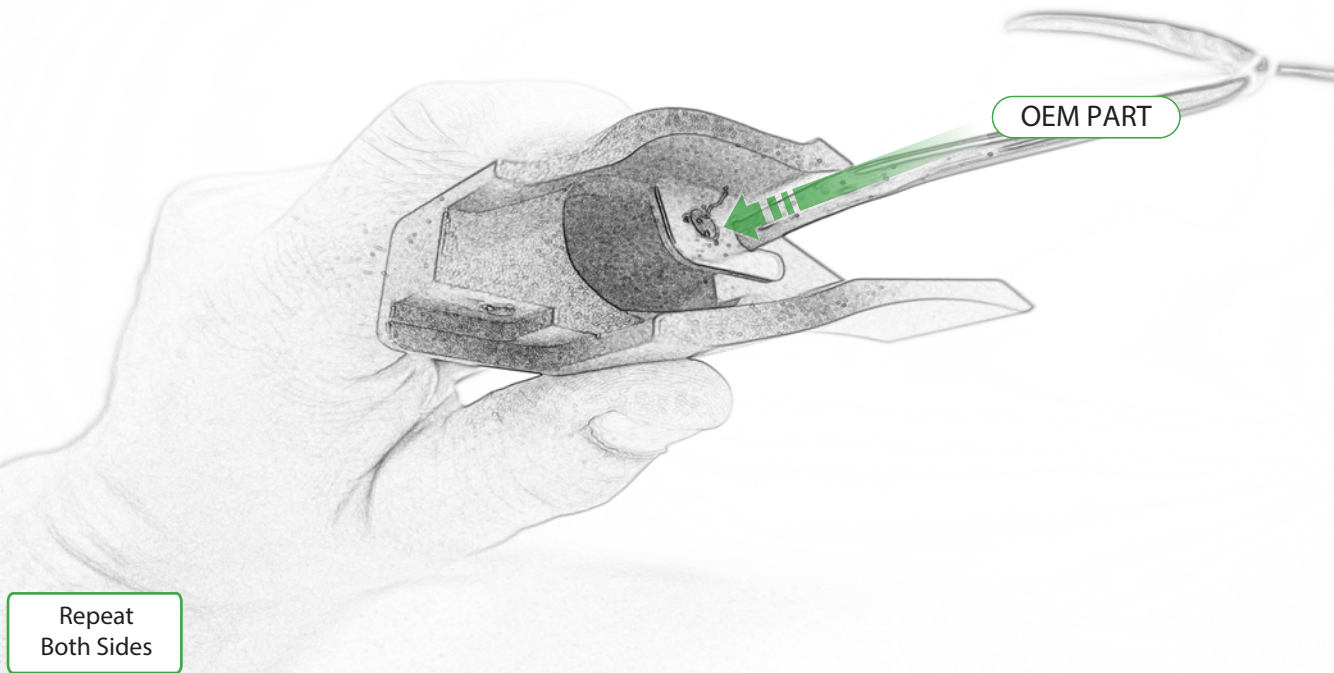

OEM PART

Repeat
Both Sides

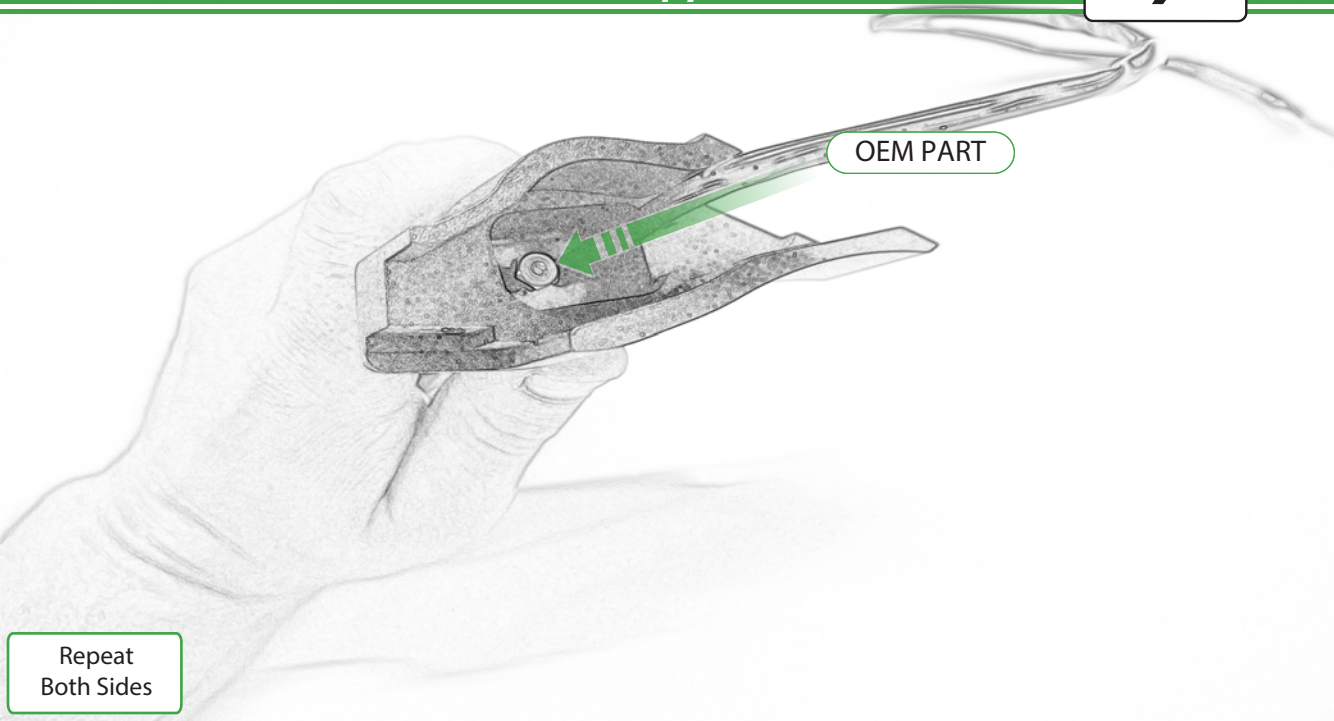

OEM PART

Repeat
Both Sides

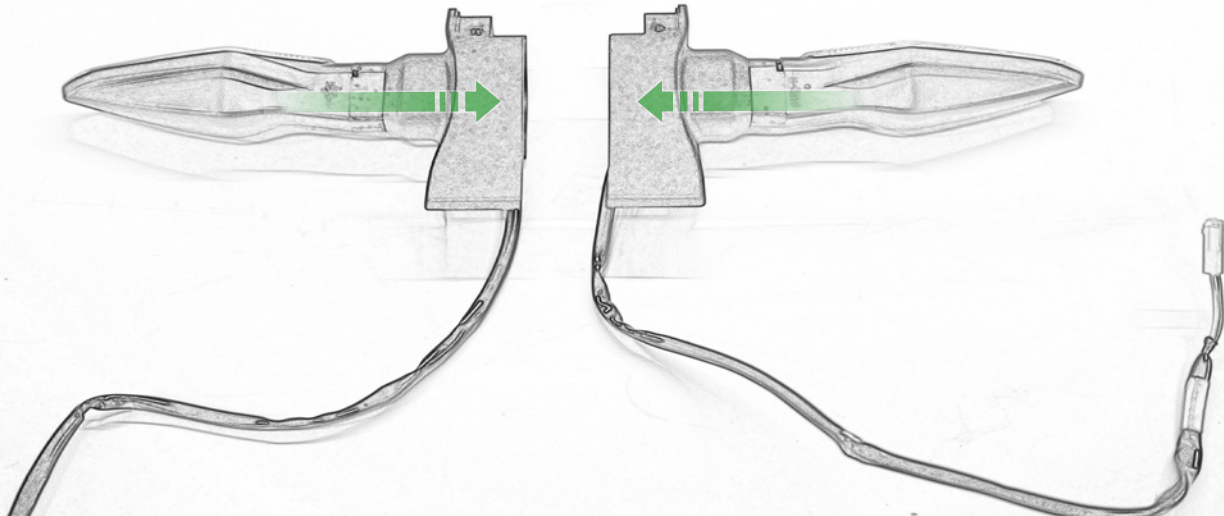

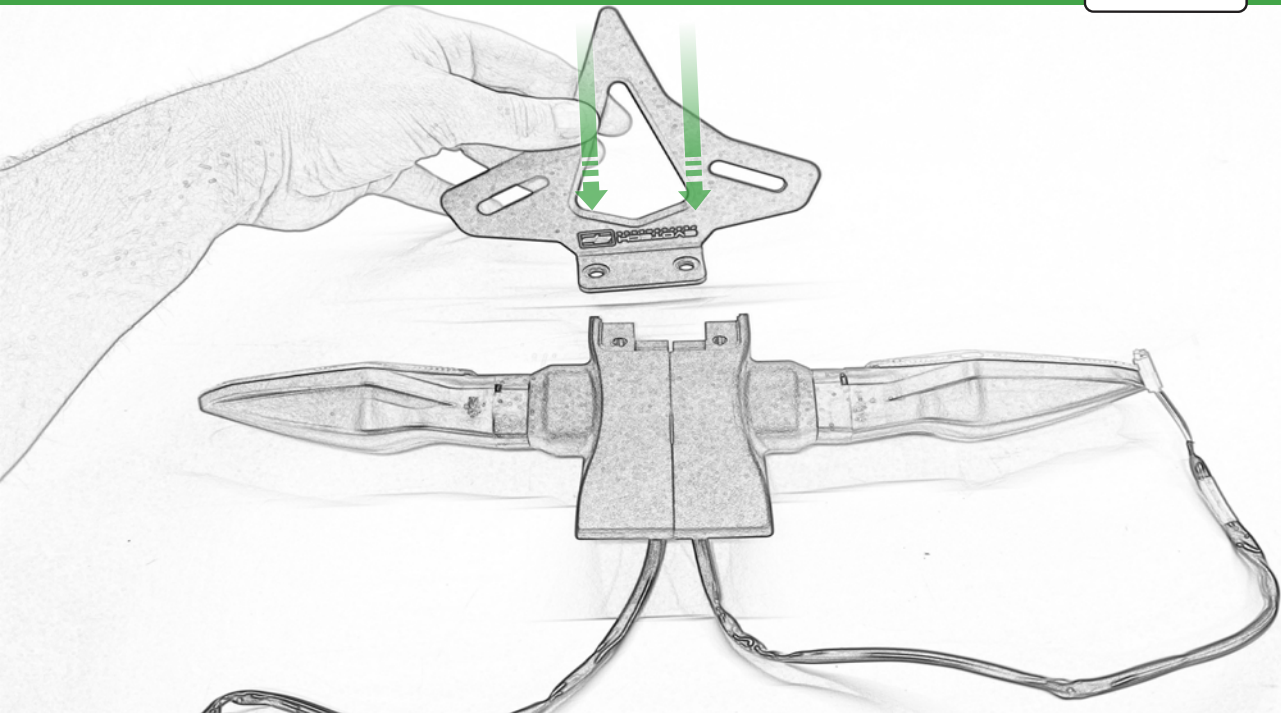

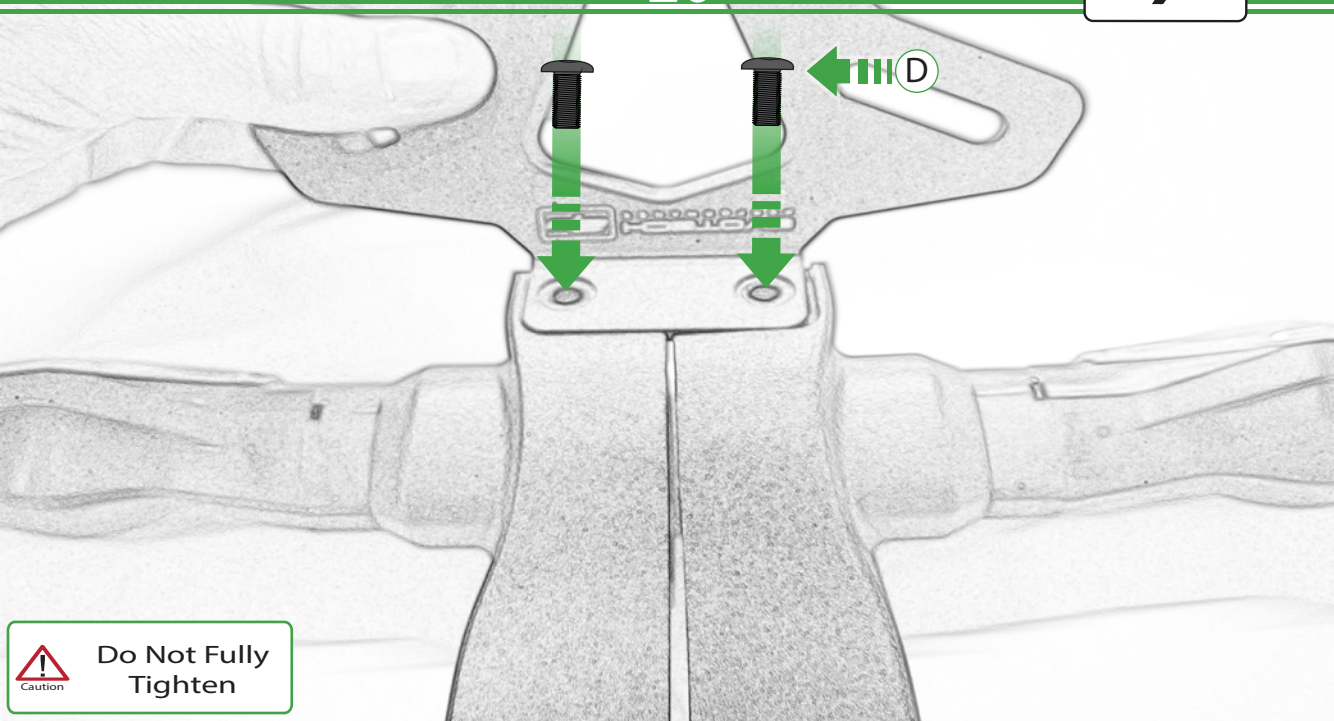

Do Not Fully Tighten

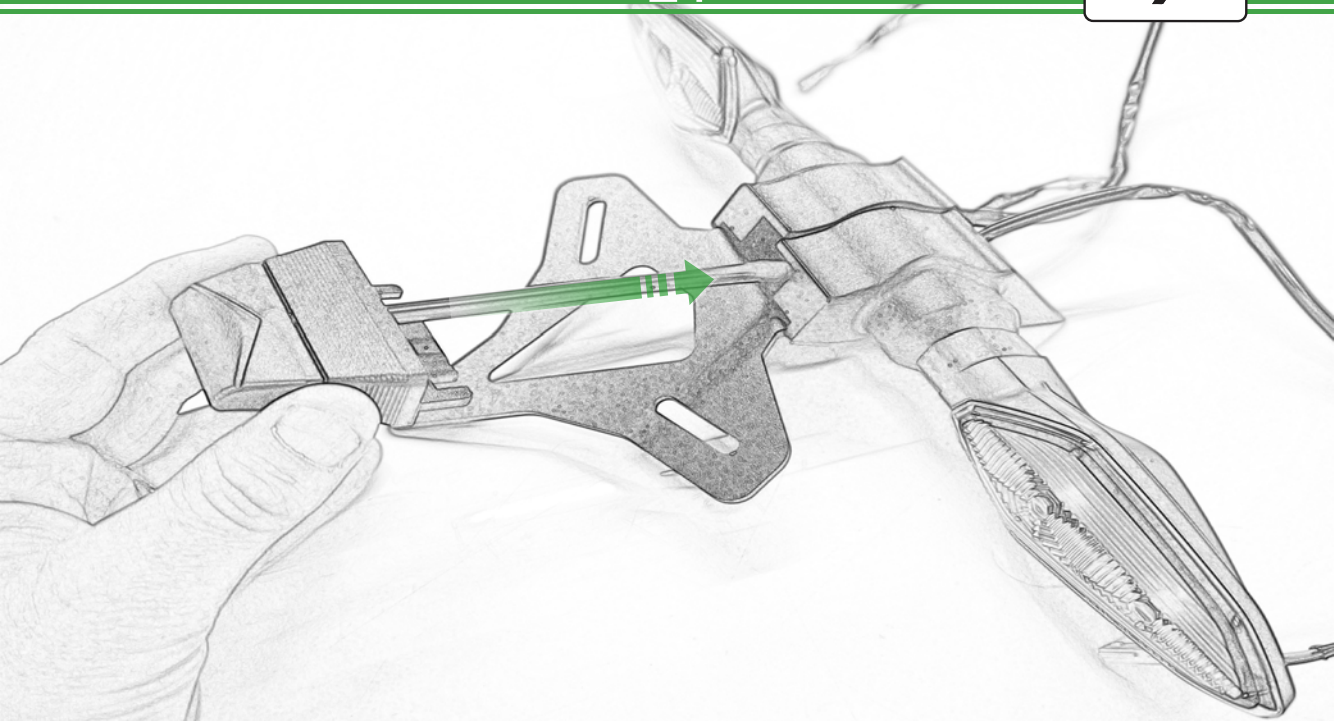

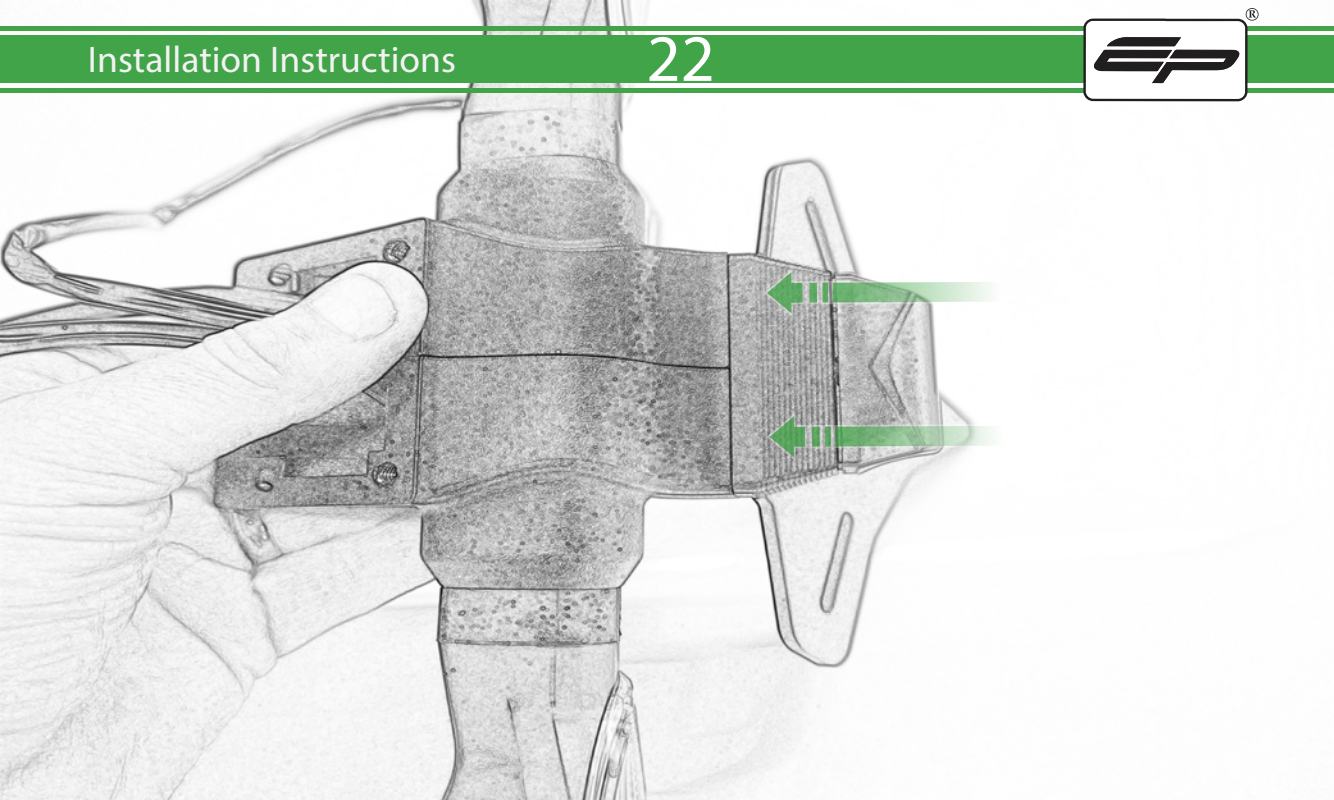

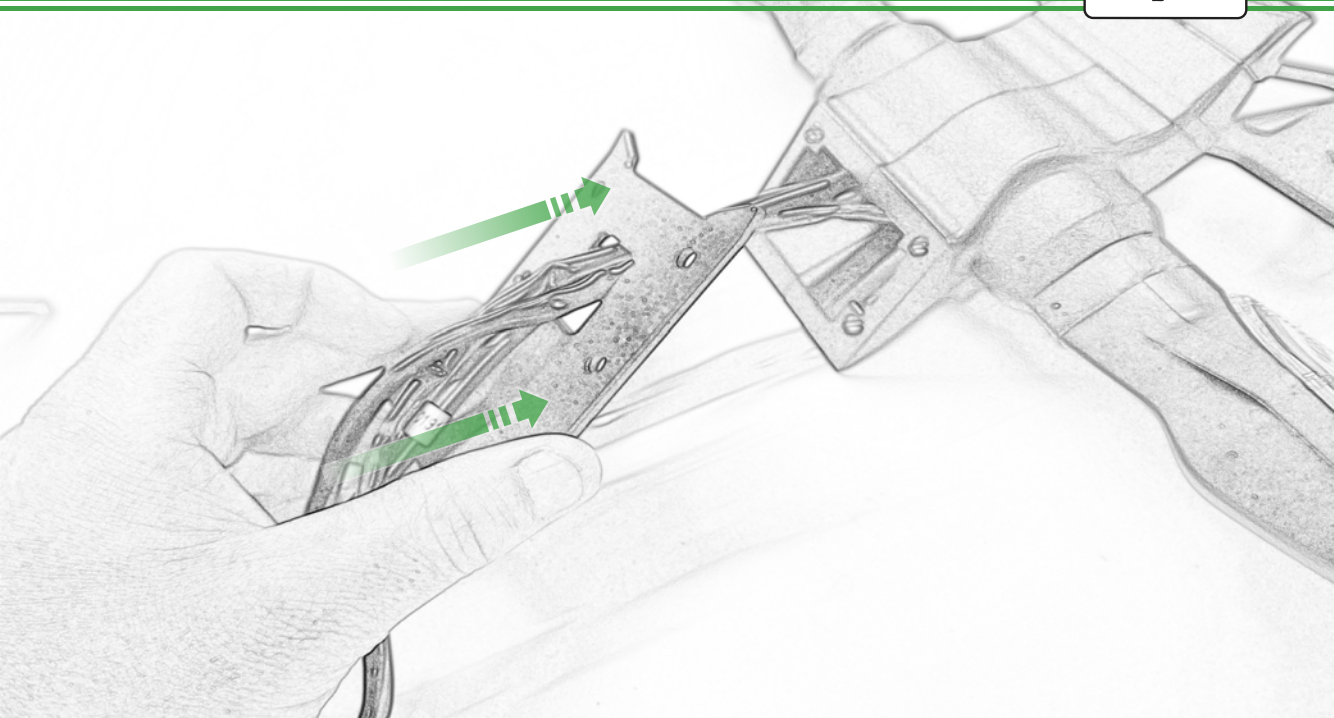

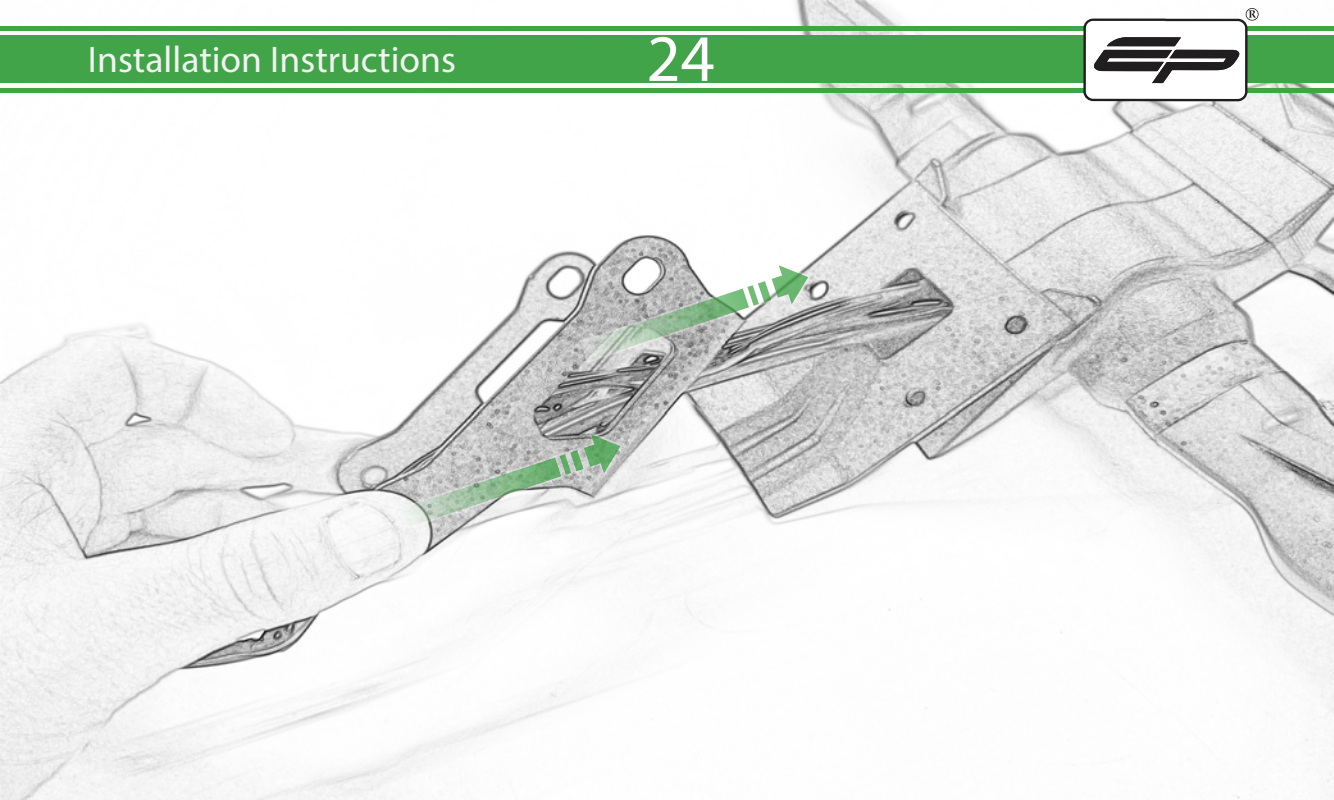

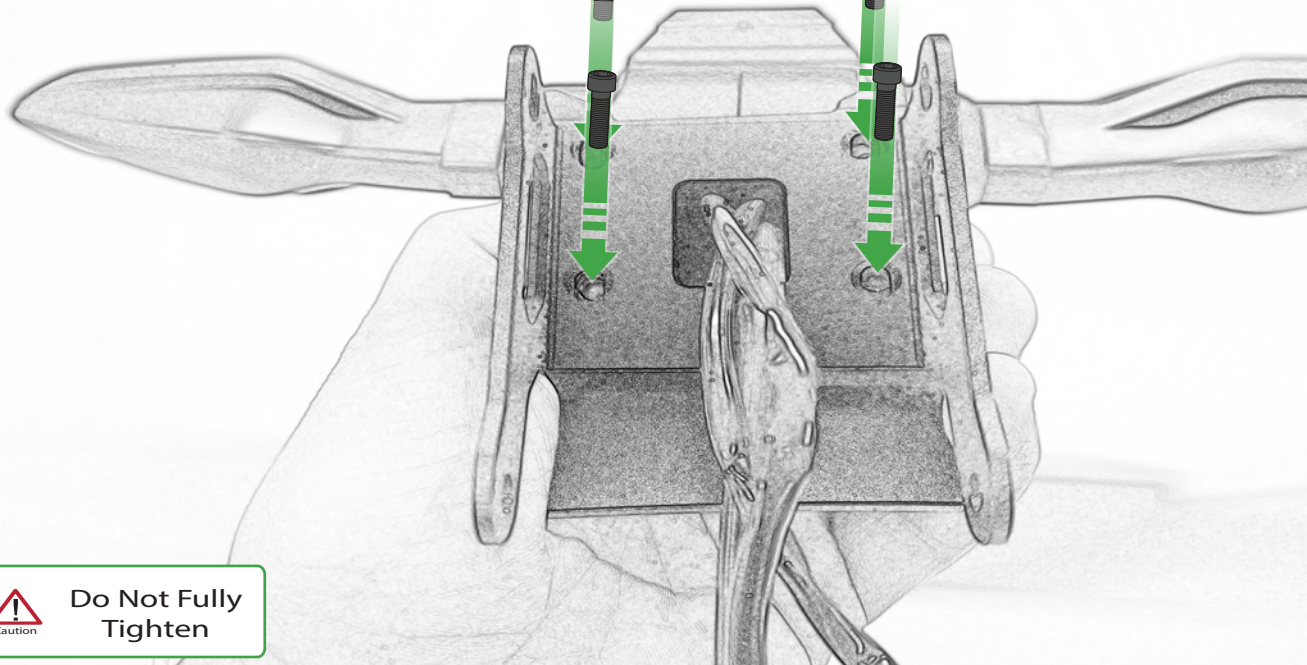

Do Not Fully Tighten

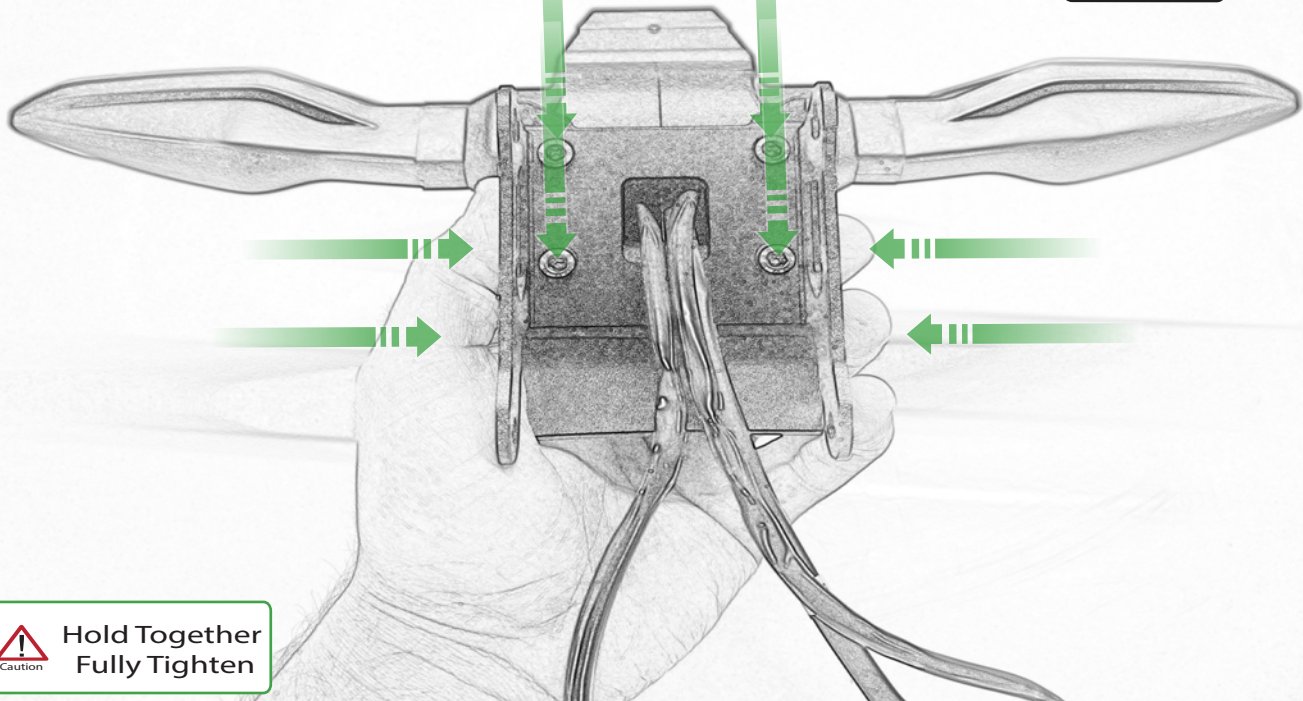

Hold Together
Fully Tighten

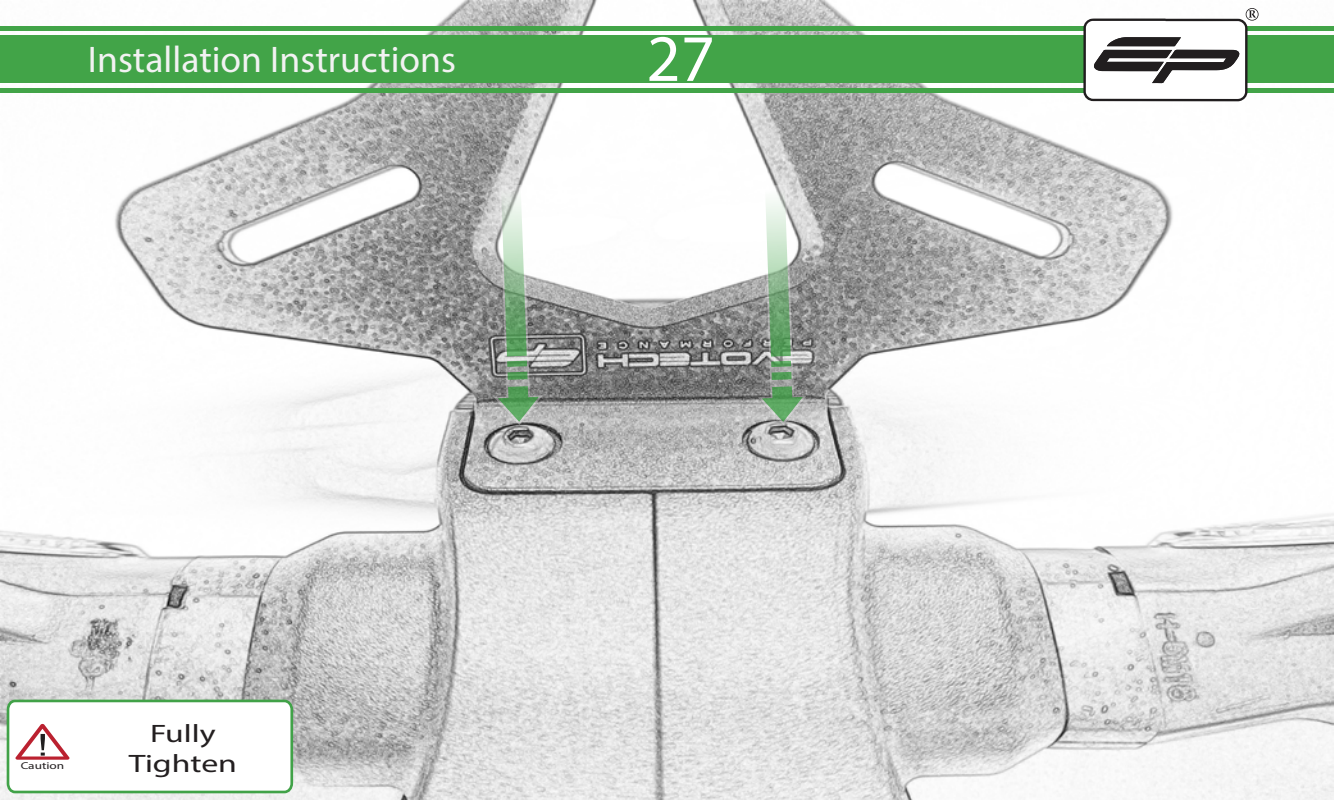

Caution

Fully
Tighten

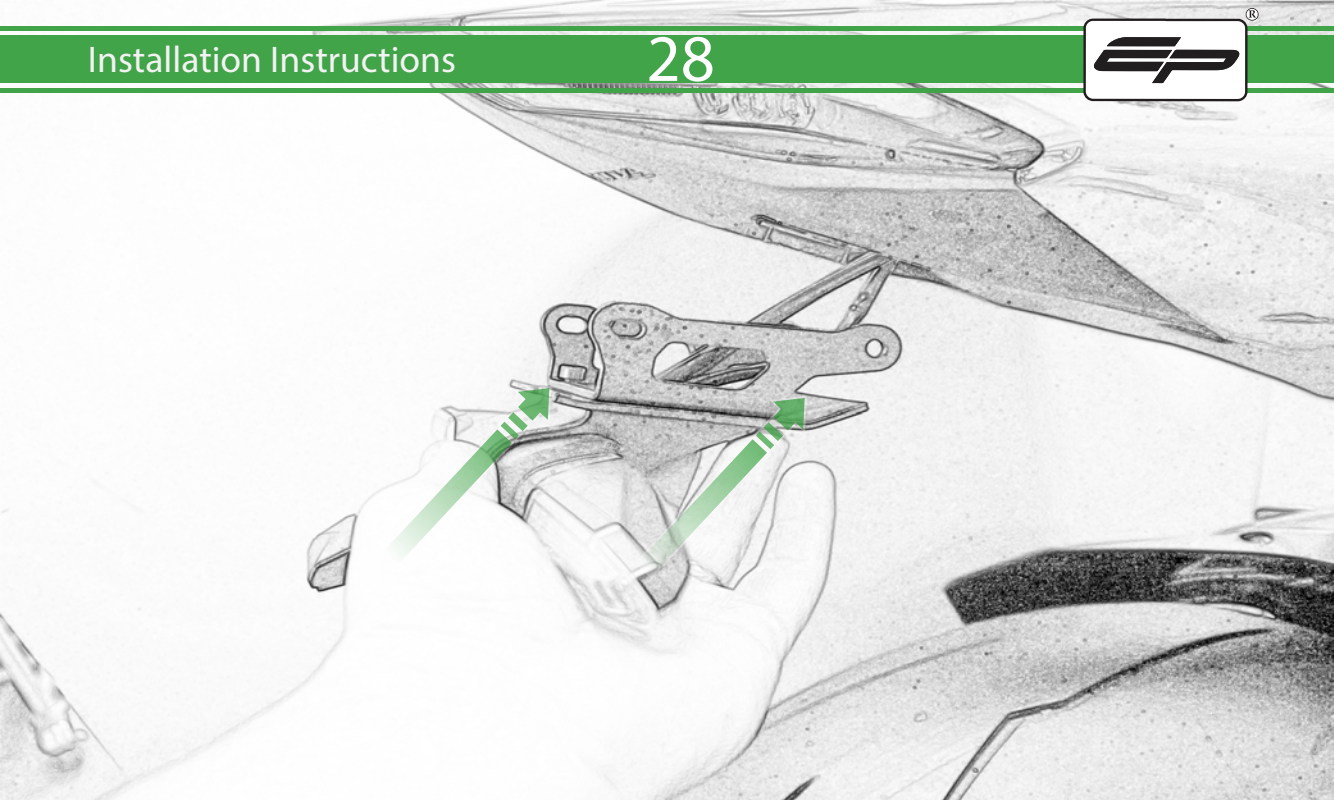

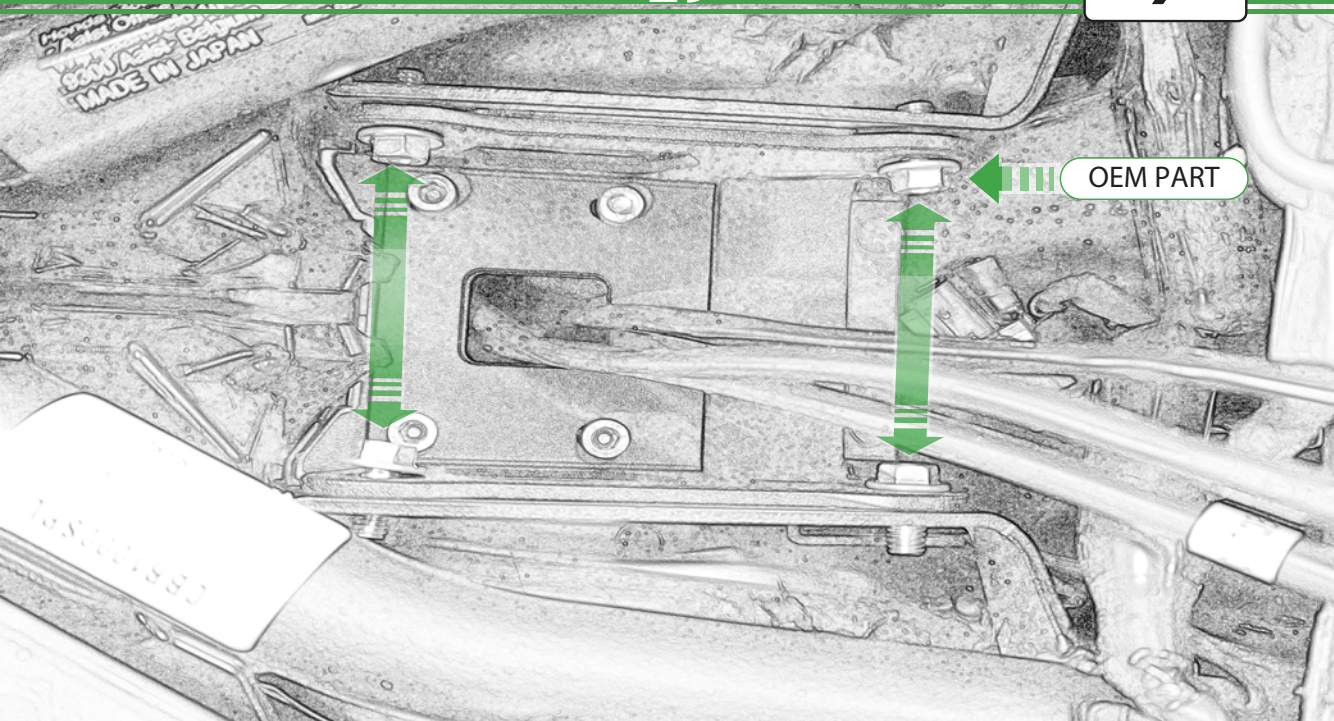

OEM PART



OEM PART



Fully Tighten

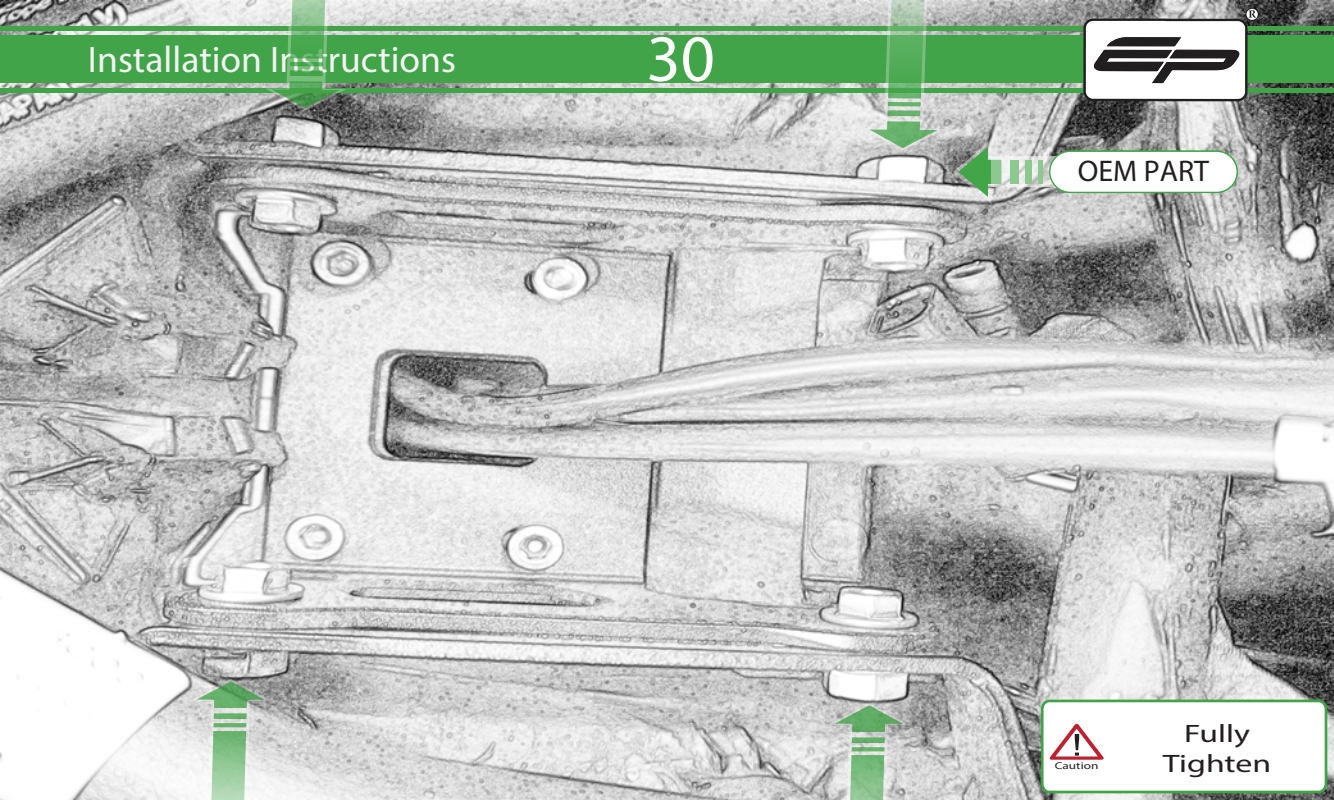

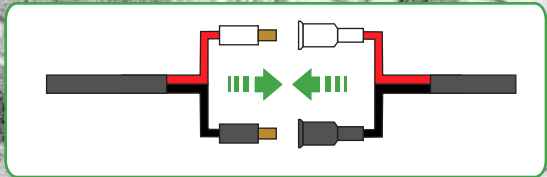
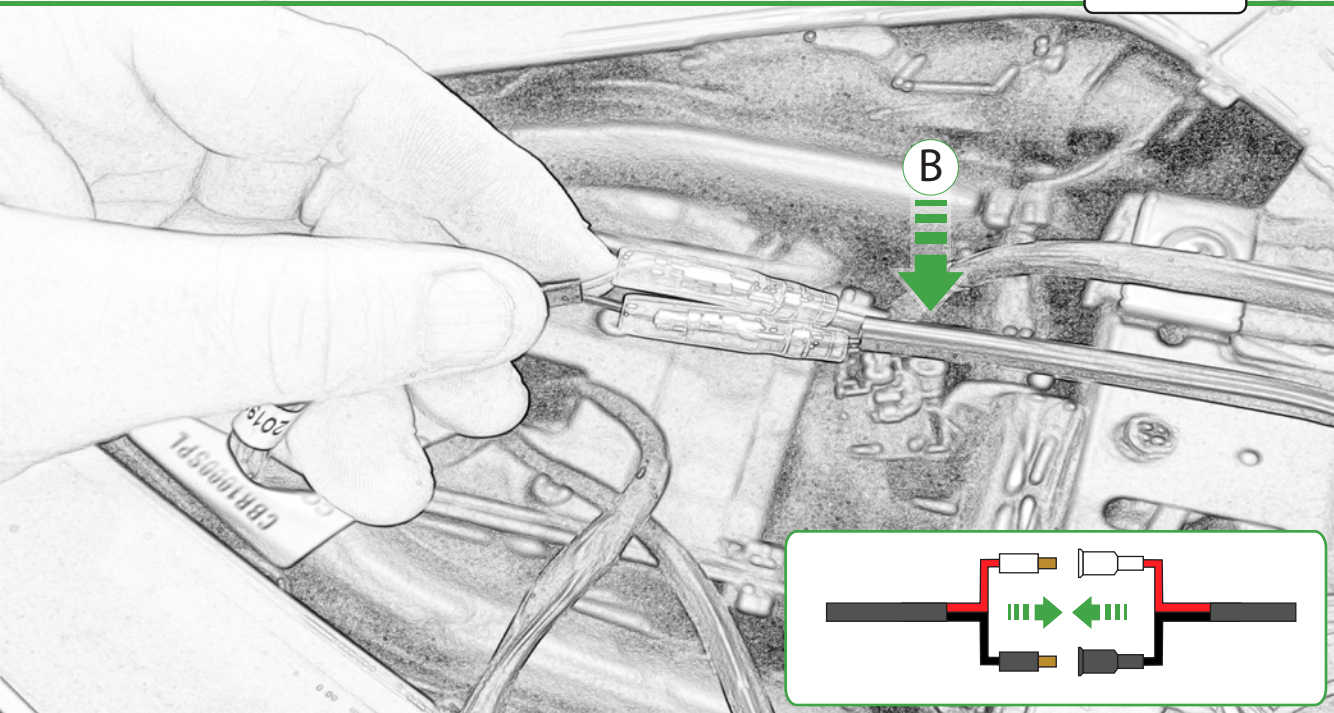

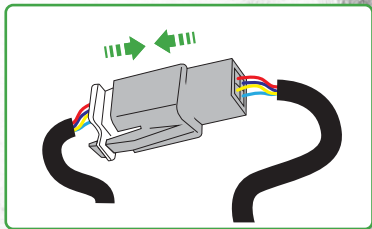

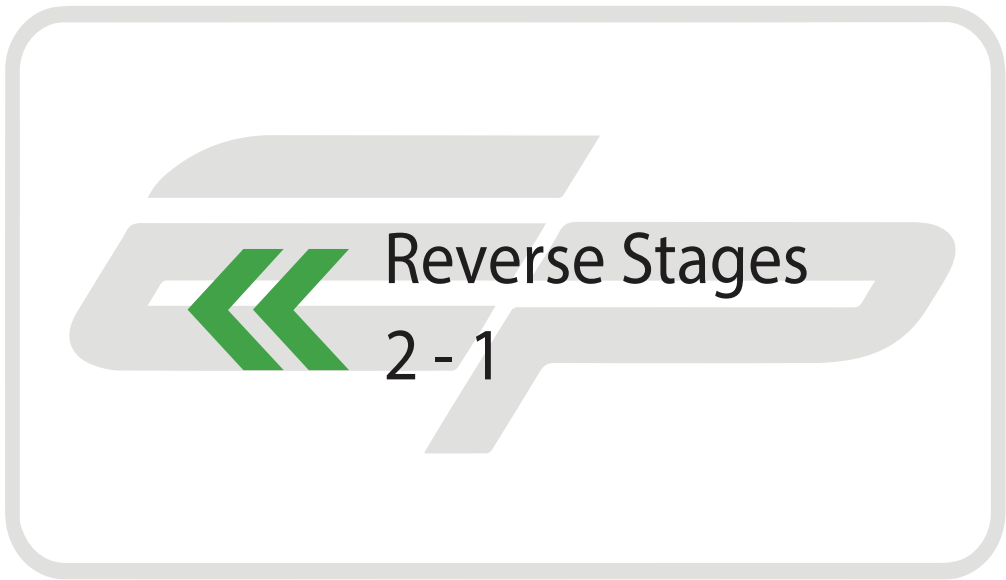

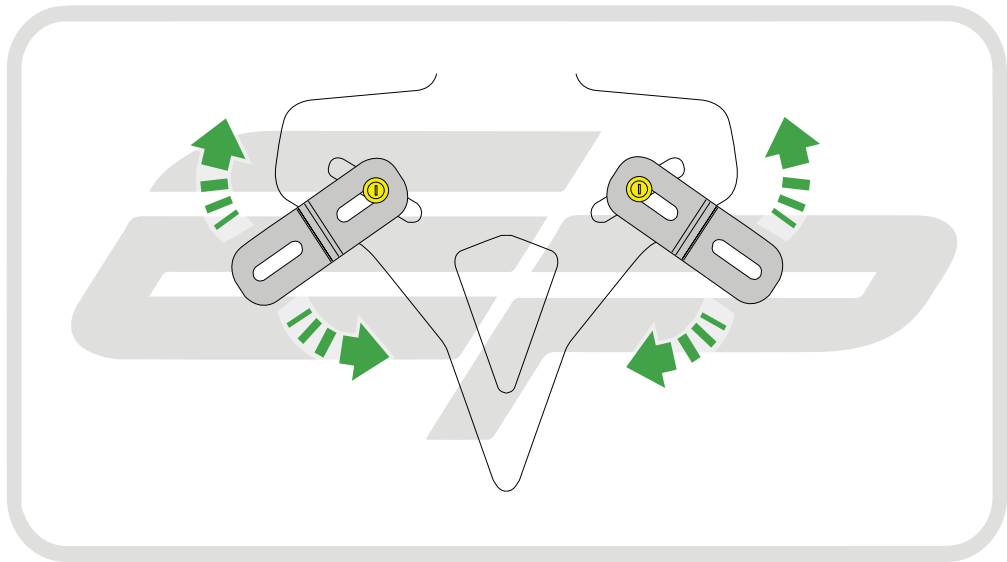

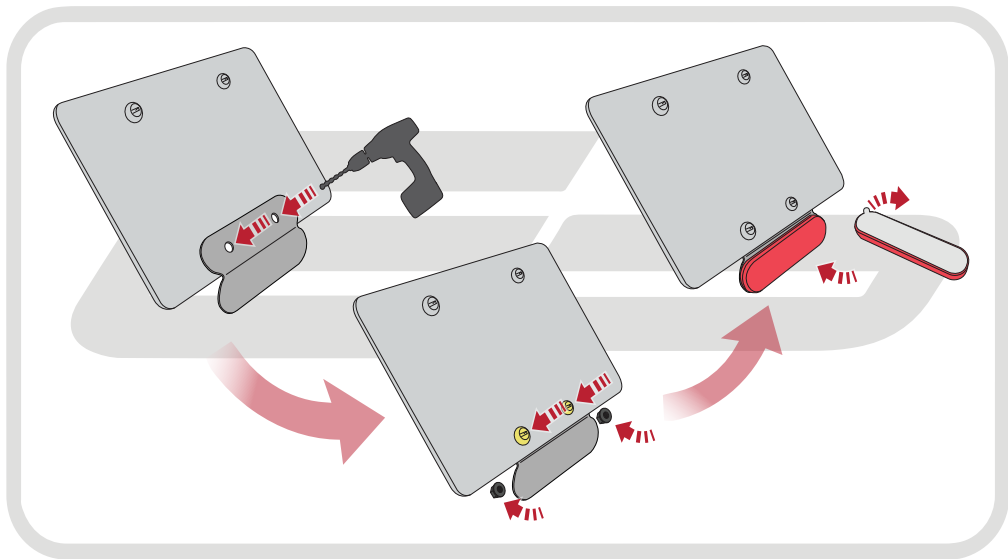



ESSENTIAL CHECKS



After installation of your tail tidy ensure that the licence plate does not contact the rear tyre when suspension is fully compressed.

Ensure all electrics including indicators, tail light, brake light and licence plate light lights are working correctly before riding the motorcycle.

It is recommended that periodic inspections are made to ensure that all fixings are fully tightend.



EVOTECH®
P E R F O R M A N C E

www.evotech-performance.com