

CÚPULA ADAPTABLE A - SCREEN FOR - WINDSCHUTZSCHEIBE FÜR HONDA NC 750 X - '16 -

Ref.: 8909
(Mod. SPORT)

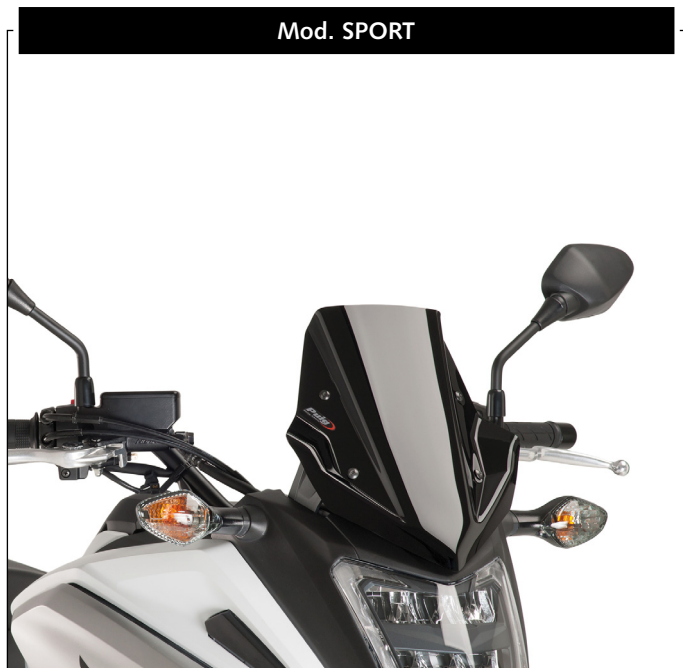



Ref.: 8910
(Mod. TOURING)

Mod. SPORT





Mod. TOURING

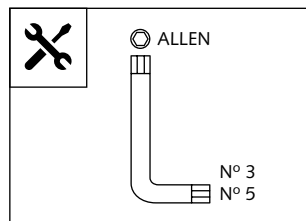

ID.	PIEZA/PART	DESCRIP.	QTY.
1		Cúpula SPORT SPORT screen (Ref. 8909)	1
		Cúpula TOURING TOURING screen (Ref. 8910)	
2		Tornillo Allen M5 x 30 ISO 7380 M5 x 30 ISO 7380 Allen screw	4
3		Arandela de goma M5x4 M5x4 rubber washer	4

Created by: www.candisseny.com



 1 persona 1 person	 10 min	Fácil - Easy
		Media-Intermediate
		Difícil-Difficult

CÚPULA ADAPTABLE A - SCREEN FOR - WINDSCHUTZSCHEIBE FÜR
HONDA NC 750 X - '16 -

INSTRUCCIONES DE MONTAJE - MOUNTING INSTRUCTIONS - MONTAGEANLEITUNG

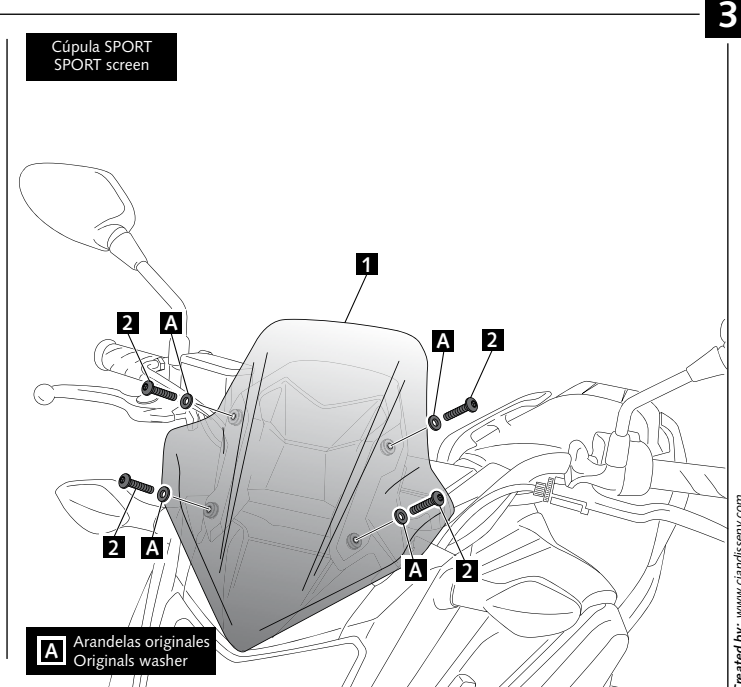
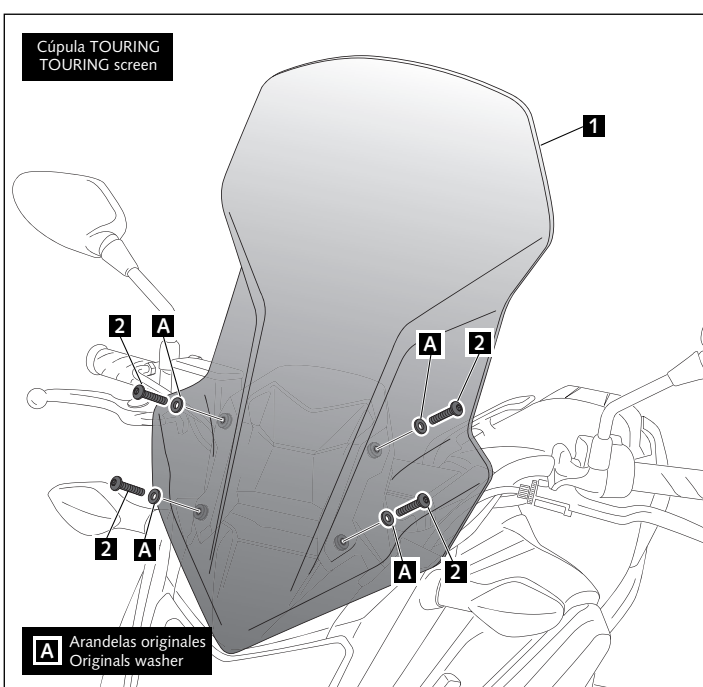
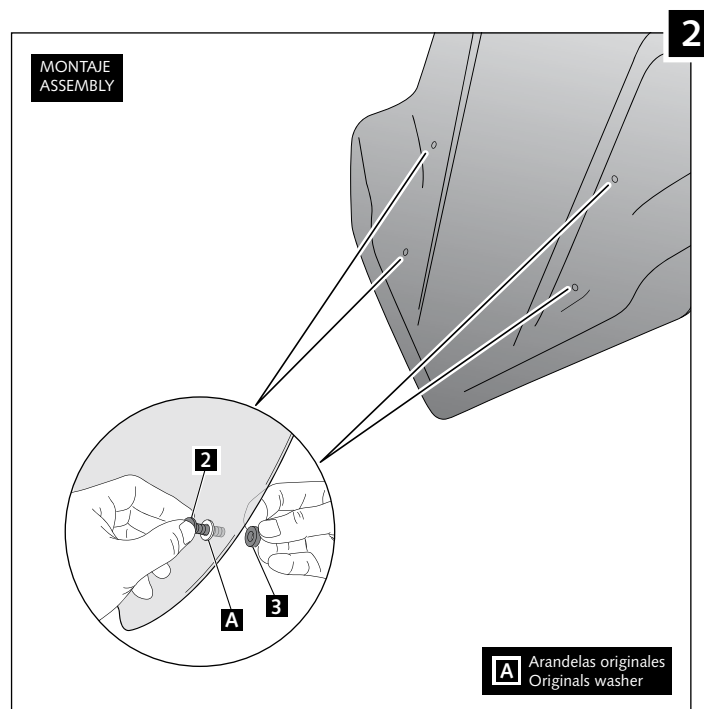
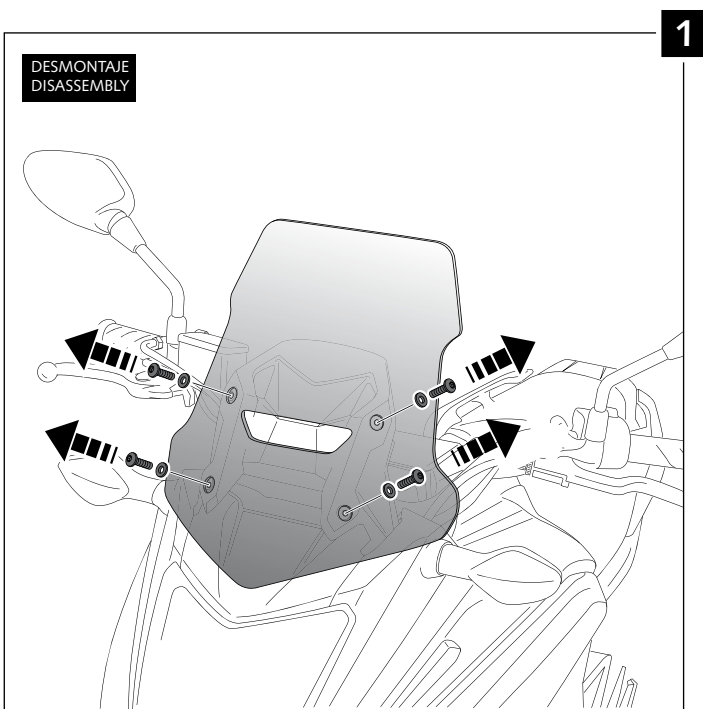

VISERA MULTIREGULABLE MULTI-ADJUSTABLE VISOR

CÚPULA TIPO
TYPE WINDSCREEN **A**



CÚPULA TIPO
TYPE WINDSCREEN **B**



CÚPULA TIPO
TYPE WINDSCREEN **C**



Ref.: 6007

Ref.: 5852

Ref.: 5853

Ahumado/Smoke

Transparente/Clear

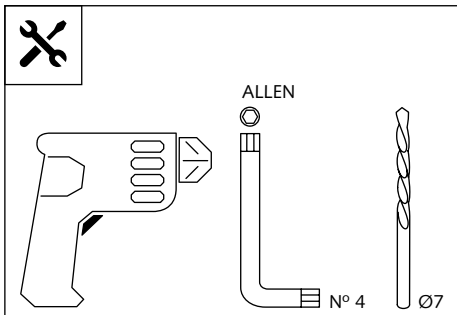

1 persona
1 person



15 min

Fácil - Easy

Media-Intermediate

Difícil-Difficult

Nota/Note:

Si la visera se suministra con la cúpula Puig, no será necesario realizar los agujeros por que ya vienen incorporados.

If the visor is supplied along with the windscreen, the windscreen will come factory-drilled so no drilling is necessary.

ID.	PIEZA / PART	DESCRIPCIÓN	DESCRIPTION	QTY.
1		Visera	Visor	1
2		Plantilla	Template	1
3		Mecanismo multiregulable	Multi-adjustable mechanism	2
4		Tapeta	Cap	4
5		Tornillo rosca plástico M6x12	Plastic thread fastener M6x12	8

VISERA MULTIREGULABLE MULTI-ADJUSTABLE VISOR

INSTRUCCIONES DE MONTAJE - MOUNTING INSTRUCTIONS - MONTAGEANLEITUNG

TIPO/TYPER A - TIPO/TYPER A - TIPO/TYPER A

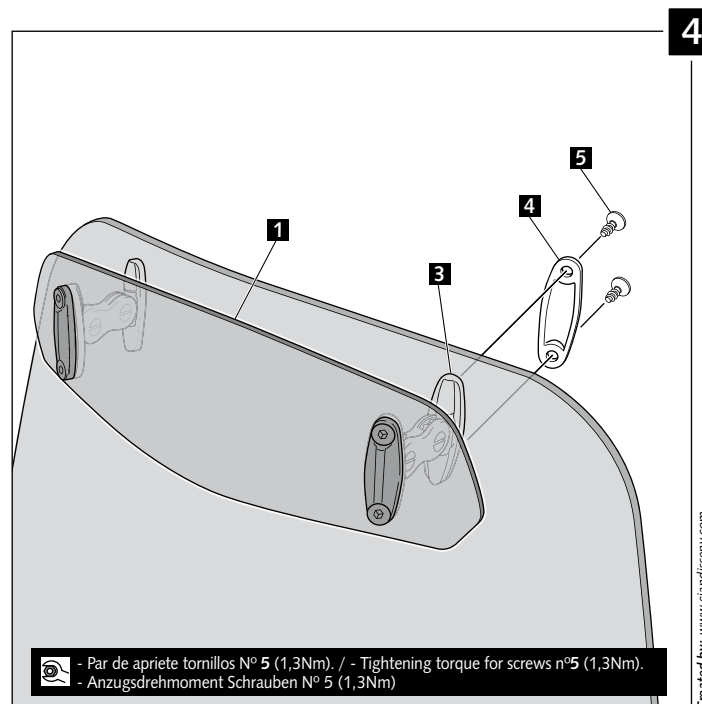
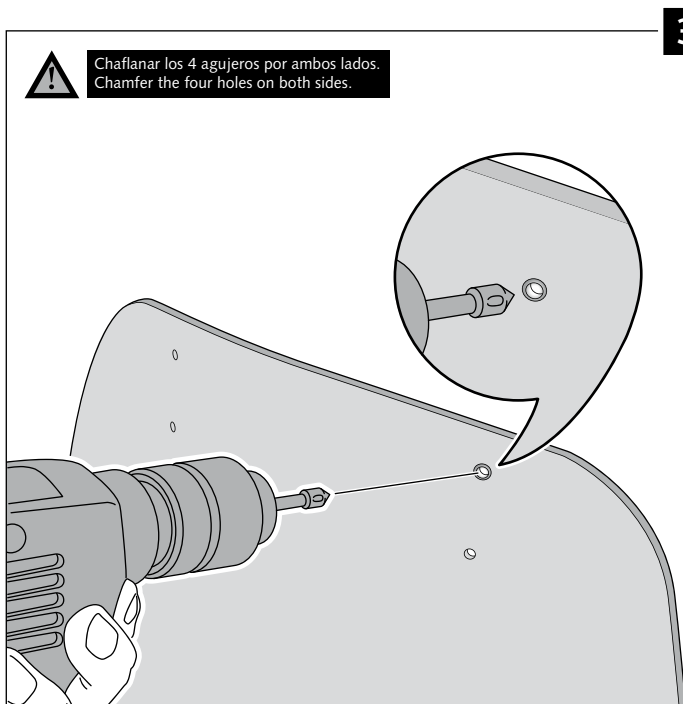
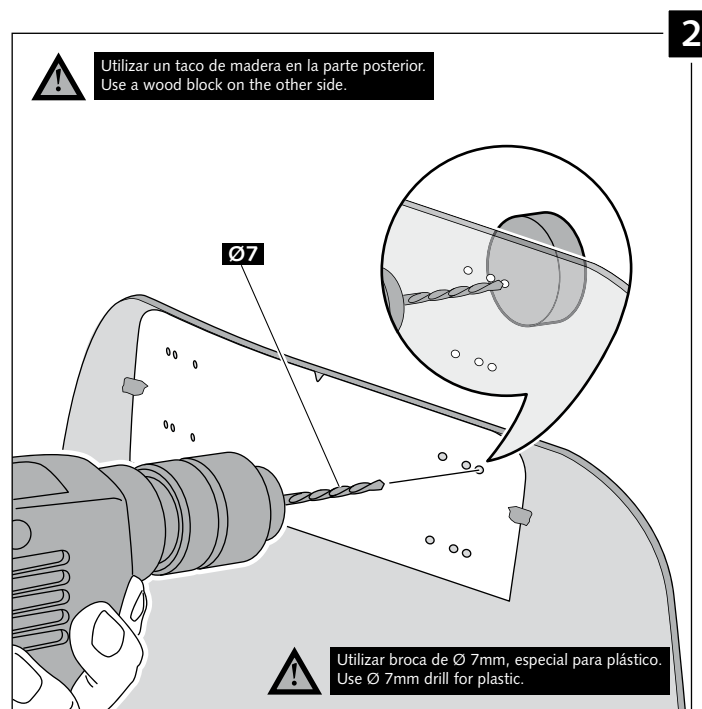
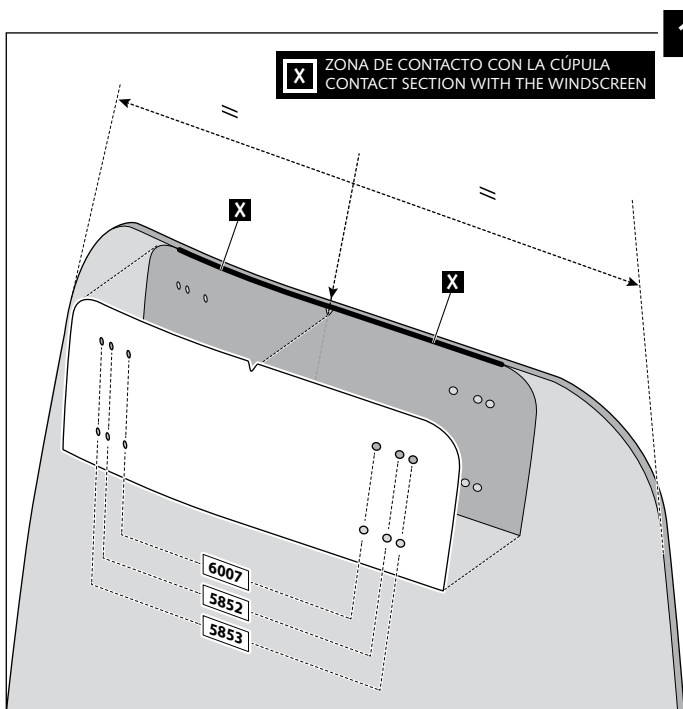

VISERA MULTIREGULABLE MULTI-ADJUSTABLE VISOR

INSTRUCCIONES DE MONTAJE - MOUNTING INSTRUCTIONS - MONTAGEANLEITUNG

TIPO/TYPER B - TIPO/TYPER B - TIPO/TYPER B

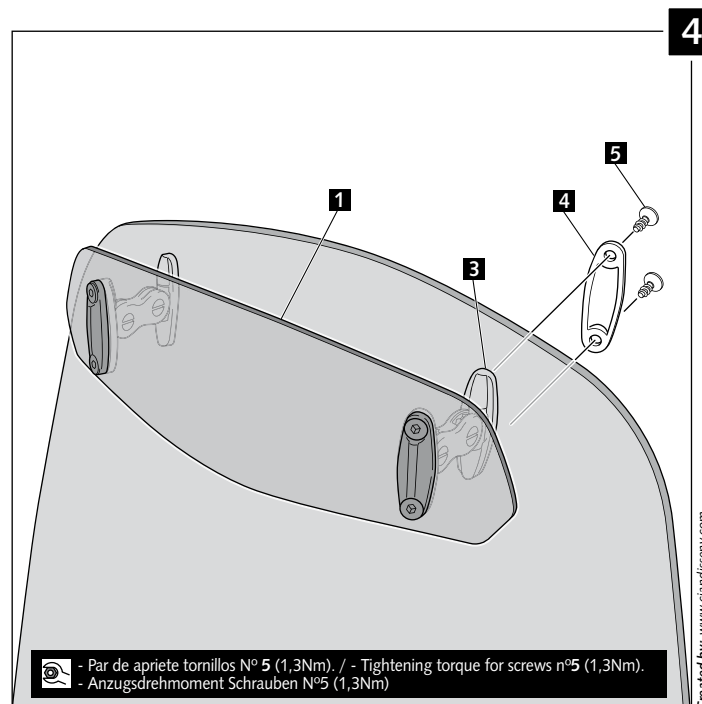
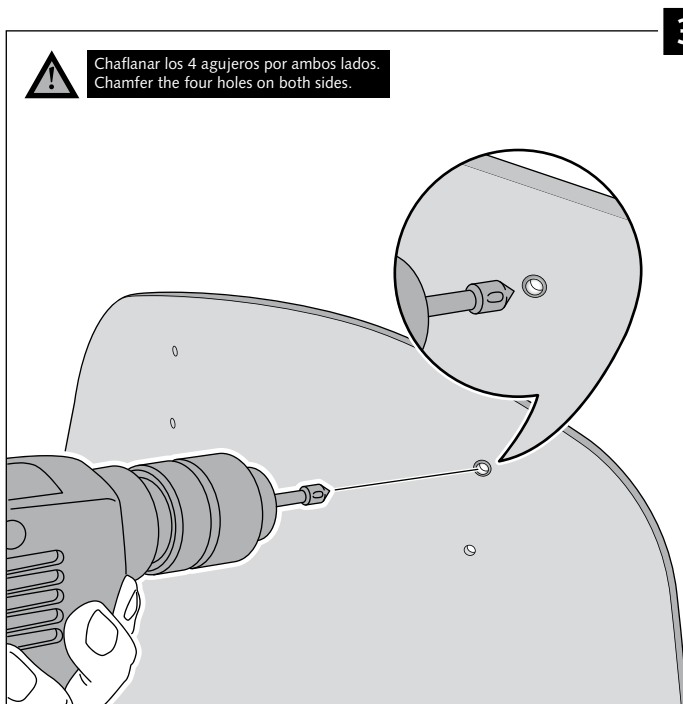
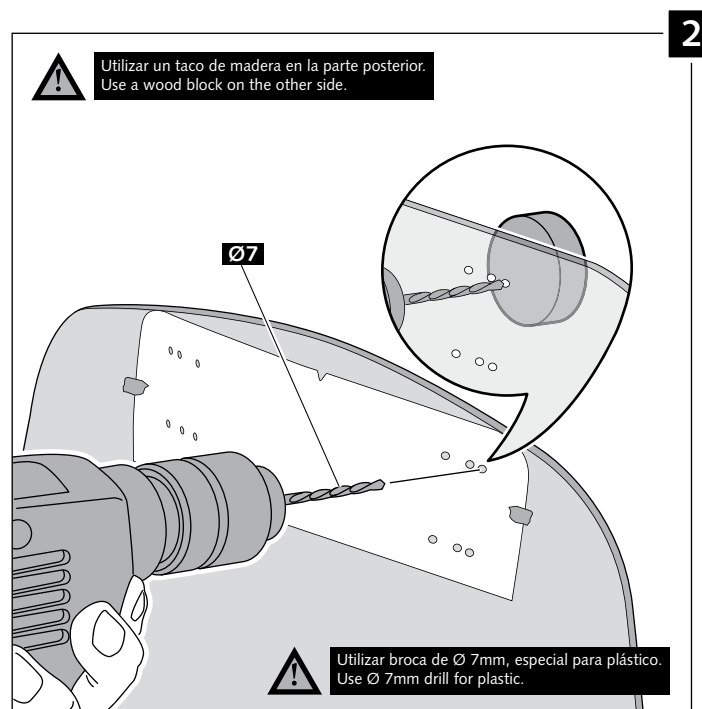
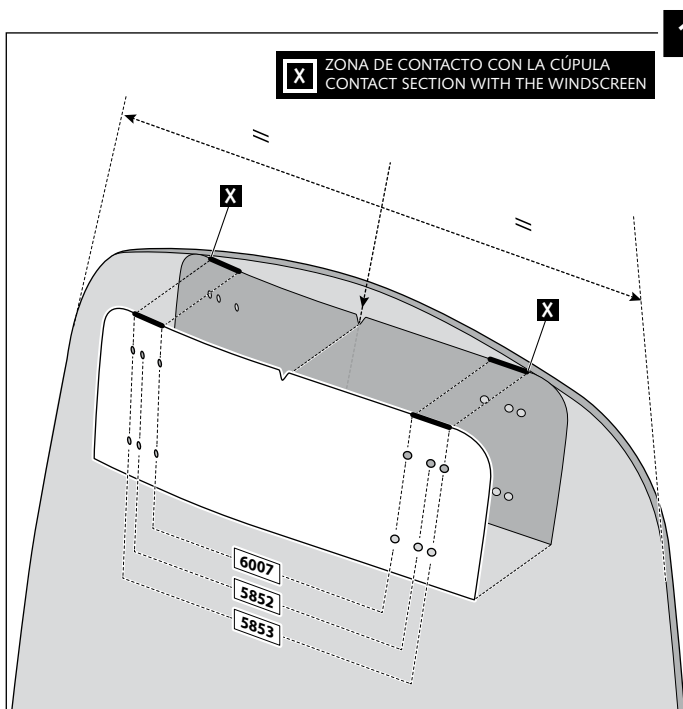

VISERA MULTIREGULABLE MULTI-ADJUSTABLE VISOR

INSTRUCCIONES DE MONTAJE - MOUNTING INSTRUCTIONS - MONTAGEANLEITUNG

TIPO/TYPER C - TIPO/TYPER C - TIPO/TYPER C

