









1109KIT - 1109KIT

KIT SPECIFICO - SPECIFIC KIT - KIT SPECIFIQUE - SPEZIFISCHES KIT - KIT ESPECÍFICO - KIT ESPECÍFICA

HONDA INTEGRA 700 (2012-2013)

N°	Descrizione	Caratteristiche	Codice	Quantità	
1	Supporto - Support - Support Halterung - Soporte - Apoio	Sp. 4mm	GL2089	2 (Dx;Sx)	
2	Supporto - Support - Support Halterung - Soporte - Apoio	Sp. 4mm	GL2434	2 (Dx;Sx)	
3	Vite - Screw Vis - Schraube Tornillo - Parafuso	TCEI M8x30	830TCE	4	
4	Componenti Originali - Original Parts Parties Originales - Original Bauteile Componentes Originales - Componentes Originais	-	-	-	-
5	Protezione Adesiva - Adhesive Protection Protection Adhesive - Schutzkleber Protección Adhesiva - Proteção Adesiva	-	Z1763	1x200mm cut in 4 pcs	
6	Componenti Originali - Original Parts Parties Originales - Original Bauteile Componentes Originales - Componentes Originais	-	-	-	-
7	Vite - Screw Vis - Schraube Tornillo - Parafuso	TBEI M8x20	820TBEI	4	
8	Distanziale - Spacer Entretoise - Distanzstueck Distanciador - Espaçador	Ø18x17 foro 8.5mm	C18L17F8,5T	4	
9	Dado - Bolt - Ecrou Mutter - Tuerca - Porca	Auto Bloccante Flangiato M8	8DADIFN	4	
10	Rondella - Washer Rondelle - Scheibe Arandela - Arruela	Ø8x14	814RON	4	



1109KIT - 1109KIT

KIT SPECIFICO - SPECIFIC KIT - KIT SPECIFIQUE - SPEZIFISCHES KIT - KIT ESPECÍFICO - KIT ESPECÍFICA

HONDA INTEGRA 700 (2012-2013)

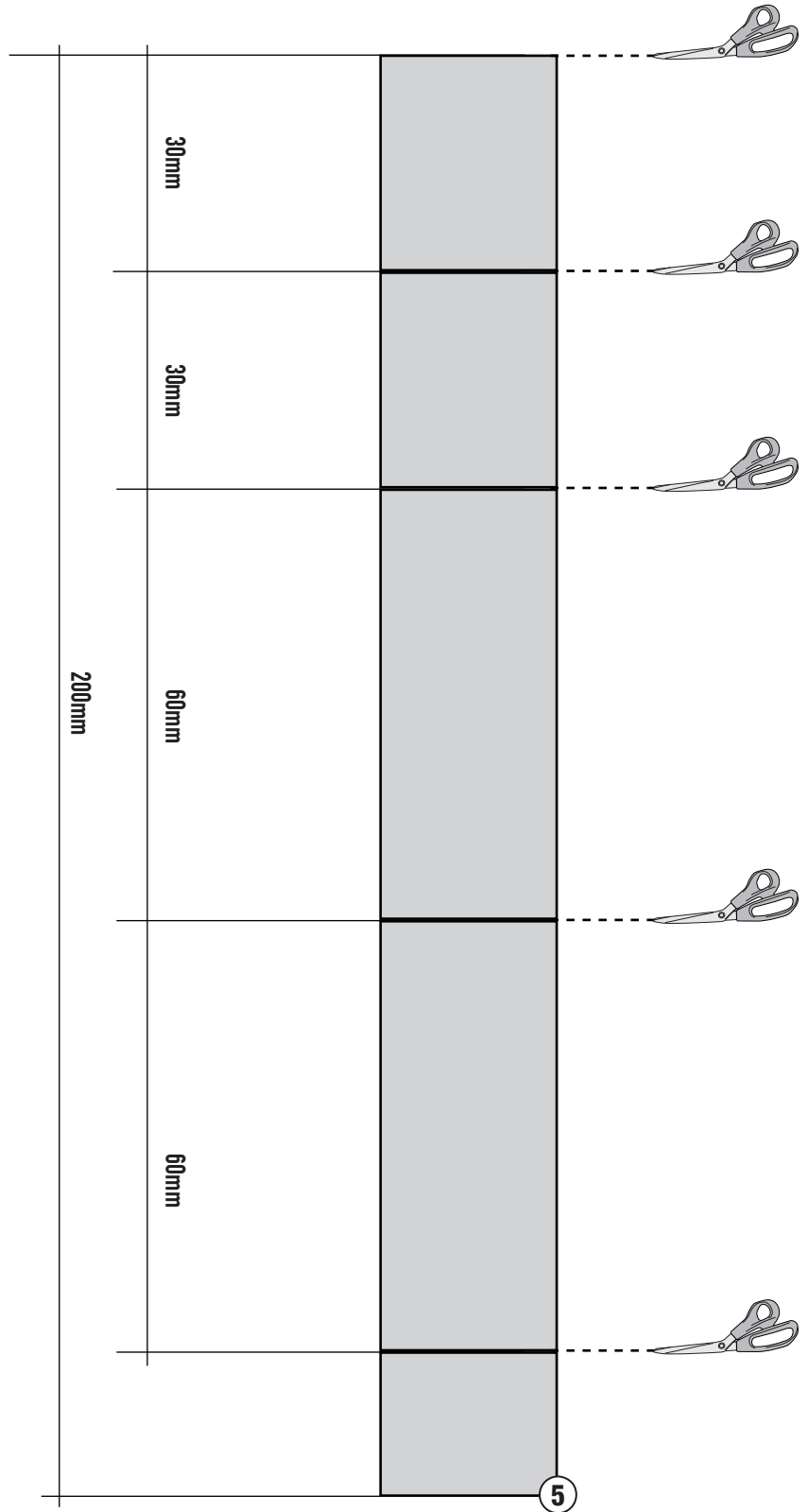
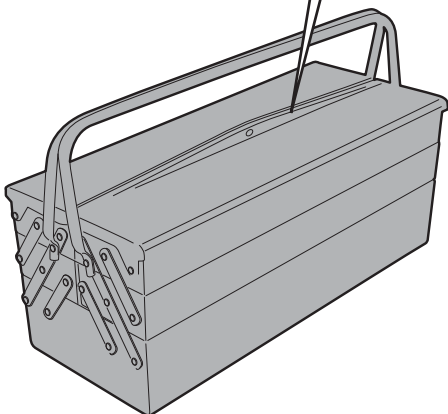
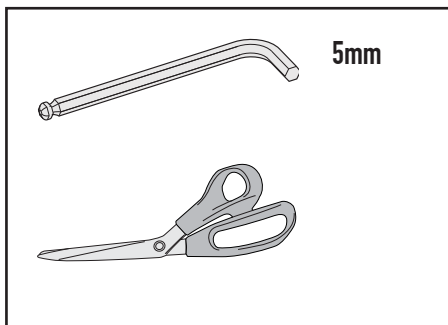

1109KIT - 1109KIT

KIT SPECIFICO - SPECIFIC KIT - KIT SPECIFIQUE - SPEZIFISCHES KIT - KIT ESPECÍFICO - KIT ESPECÍFICA

HONDA INTEGRA 700 (2012-2013)

