















N°	PIÈCES / PARTS	QTY	DÉSIGNATION	DESCRIPTION
1		x1	Capot de selle	Seat cover
2		x1	Plaque aluminium gauche	Left aluminum plate
3		x1	Plaque aluminium droite	Right aluminum plate
4		x1	Patte fixation crochet gauche	Left hook bracket
5		x1	Patte fixation crochet droite	Right hook bracket
6		x1	Patte fixation 90°	90 ° fixing bracket
7		x2	Agrafe filetée M6	M6 Threaded clip
8		x2	Vis BHC noire M5 x 15	M5 x 15 Black BHC screw
9		x2	Vis BHC noire M6 x 15	M6 x 15 Black BHC screw
10		x6	Vis FHc M4 x 16	M4 x 16 FHc screw
11		x2	Scotch mousse Ep: 5 L: 60 mm	Thick: 5 L: 60 mm Scotch foam
12		x6	Insert caoutchouc M4	M4 Rubber insert
13		x2	Insert caoutchouc M5	M5 Rubber insert

1 Montage - Assembly

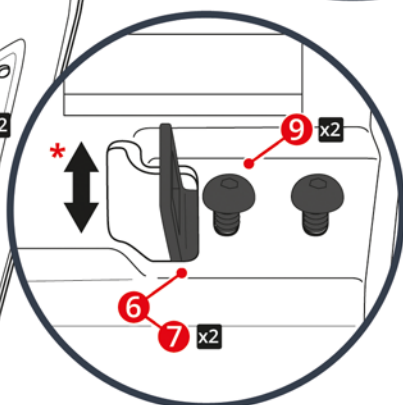
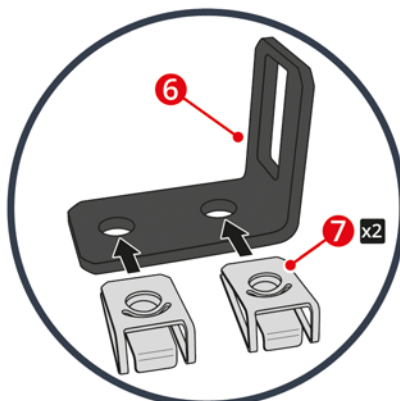
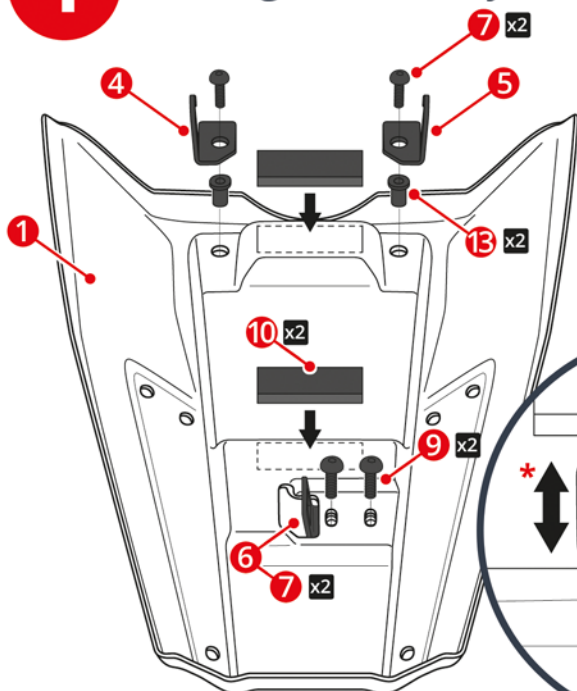

Démontage Disassembly

2

* Pour ajuster le capot
To adjust seat cover

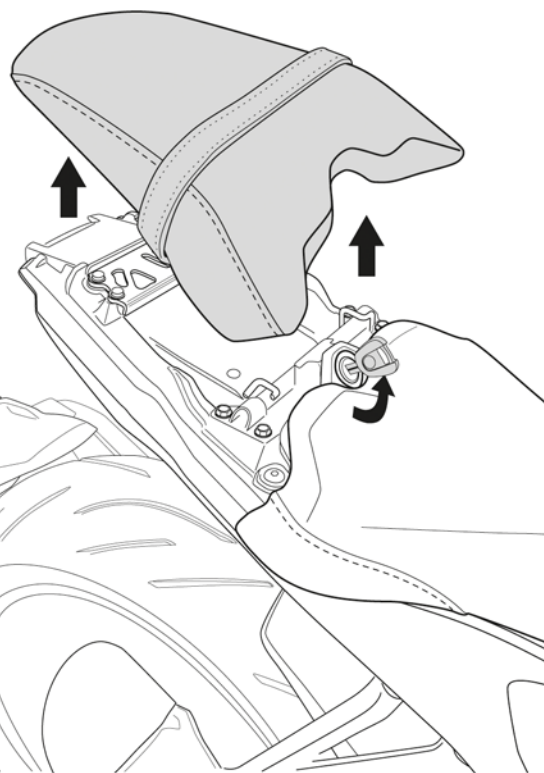

3 Montage - Assembly

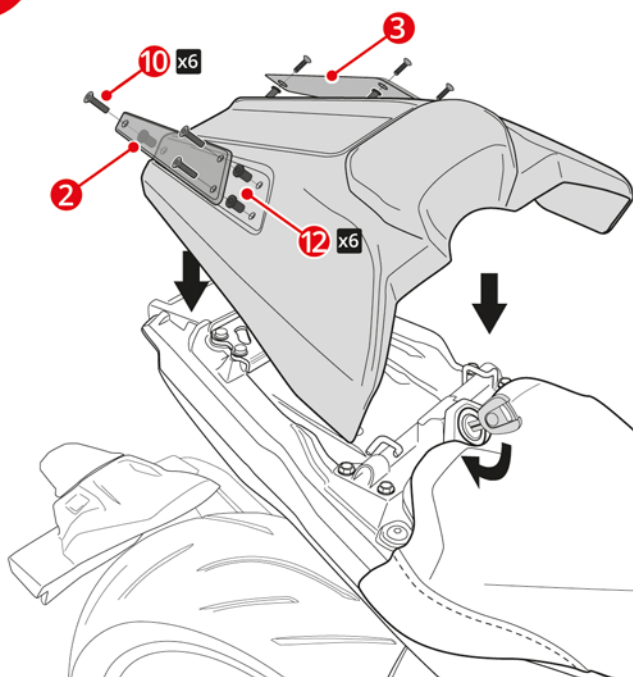

! Les pièces peintes et vernies ne sont pas garanties contre les lavages vapeur « haute pression » ou les produits nettoyants agressifs qui peuvent les endommager et décoller le vernis. Nous conseillons d'ailleurs, d'après les données techniques de nos fournisseurs en peinture, d'attendre un mois afin d'obtenir une polymérisation complète du vernis. Tout accessoire monté ne sera plus considéré comme neuf et ne sera ni repris ni échangé. Les accessoires Ermax sont conçus pour des montes d'origine. Ils ne seront pas garantis s'ils sont utilisés dans d'autres conditions. En raison des tolérances de fabrication des véhicules, indépendantes de notre volonté, certains produits Ermax peuvent nécessiter des ajustements lors de la fixation. Attention aux serrages excessifs qui pourraient abîmer ou casser nos accessoires en plastique et les vis en aluminium.

Painted and varnished parts are not guaranteed against high pressure steam washes or aggressive cleaning products which can damage them and unstuck the varnish. We advise moreover, according to the technical data of our painting suppliers, to wait one month to obtain a complete polymerization of varnish. Accessories gone up on the motorbike will not be any more considered as new and will be neither retaken nor exchanged. Ermax accessories are foreseen for original equipments. They will not be guaranteed if they are used in others conditions. Due to vehicles made tolerances, beyond our control, some Ermax products might need adjusting to fit. Care to excessive clampings which may damage or break our plastic accessories and aluminium screws.